

MANUFACTURE HORLOGÈRE

RUE SAINT MAURICE 1-CH 2800 DELEMONT - SWITZERLAND
TEL : +41 (0)32 42194 00 - MAIL : INFO@SWIZA.CH

WWW.LEPEE1839.CH

L'ÉPÉE 1839

THE PREMIER CLOCK
MANUFACTURE IN SWITZERLAND

For over 180 years, L'Épée has been at the forefront of watch and clock making. Today, it is the unique specialised manufacture in Switzerland dedicated to making high-end clocks.

L'Épée was founded in 1839, initially to make watch components and music box, by Auguste L'Épée who set up the business near Besançon, France. The L'Épée hallmark was that all parts were made entirely by hand.

From 1850 onwards, the manufacture became a leading light in the production of 'platform' escapements, creating regulators especially for alarm clocks, table clocks and musical watches. By 1877, it was making 24,000 platform escapements annually. The manufacture became a well-known specialist owning a large number of patents on special escapements such as anti-knocking, auto-starting and constant-force escapements and the chief supplier of escapements to several celebrated watchmakers of the day. L'Épée has won a number of gold awards at International Exhibitions.

During the 20th century, L'Épée owed much of its reputation to its superlative carriage clocks and, for many, L'Épée was the clock of the influential and powerful; it was also the gift of choice by French government officials to elite guests. In 1976 when the Concorde supersonic aircraft entered commercial service, L'Épée wall clocks were chosen to furnish the cabins, providing passengers with visual feedback of the time.

In 1994, L'Épée showed its thirst for a challenge when it built the world's biggest clock with compensated pendulum, the Giant Regulator. At 2.2m high, it weighs 1.2 tons – the mechanical movement alone weighs 120kg – and required 2,800 man-hours of work.

L'Épée is now based in Delémont in the Swiss Jura Mountains. Under the guidance of CEO Arnaud Nicolas, L'Épée 1839 has developed an exceptional table clock collection, encompassing a range of sophisticated classic carriage clocks, contemporary design clocks (Le Duel, La Tour...) and avant-garde horological sculptures (Sherman, Starfleet Machine, Arachnophobia...) launched since the celebration of its 175th anniversary. This collection is intended to shock, evoke and inspire people, not to toe the line. L'Épée clocks feature complications including retrograde seconds, power reserve indicators, perpetual calendars, tourbillons and striking mechanisms – all designed and manufactured in-house. Ultra-long power reserves have become a signature of the brand as well as superlative fine finishing.

When Know-How becomes Art



1839

Creation

At the age of 41, Auguste L'Epée (1798-1875) joined forces with Pierre-Henri Païr from Geneva to found the L'Epée Manufacture in Saint Suzanne in the Doubs department of France.

At the time, the Manufacture produced horological products and music boxes.

1850

The escapement

Keen to enrich its savoir-faire, the L'Epée Manufacture started producing platform escapements for prestigious alarm clocks and carriage clocks makers. This was a key turning point in the company's development.

1857

Expertise and patents

Just seven years after launching this new line of business, L'Epée submitted its first patents to the authorities to establish and protect its expertise.

The Manufacture won recognition throughout the clockmaking world for its high-quality platform escapements, several of which presented highly specific systems that were very useful at the time, placing the company at the forefront of the horological scene. Some of these patents, such as those protecting the "anti-knocking" system, the "auto-starting" mechanism, and the constant-force escapement, made a lasting impression on their era.

1877
1889



Record-breaking annual production

The Manufacture's reputation defined it as both the leader and a reference in escapements.

The company's annual production of platform escapements gradually increased over two decades, culminating at 200,000 platform escapements in 1889 — nothing short of exceptional for the time!

1889
1902

Gold medals

This growing success was rewarded with various gold medals at the World Fairs held in Paris in 1889 and 1900, in Vienna in 1892, in Hanoi in 1902, and in America and the United Kingdom.



20th

Early 20th century Diversification

During these first few decades, the L'Epée Manufacture decided to diversify by producing other mechanical movements for both clockmaking (precision instruments, for example) and associated industries.

1975

Luxury watchmaking

1975 marked a major turning point for the Manufacture. New company directors reoriented production to focus on the design and creation of luxury clocks and carriage clocks.

1976

Aeronautics

In 1976, the Manufacture participated in a major aeronautical project, the Concorde, by fitting the first commercial flights of this supersonic airplane with wall clocks.

They remain the only clocks ever fitted in supersonic aircraft used in civil aviation.

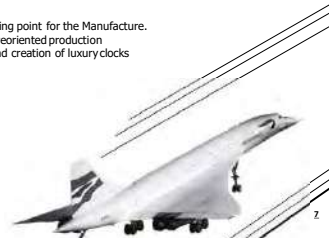

HISTORY & HERITAGE



1994

The Giant Regulator

L'Epée unveiled the largest clock in the world, known as "the Giant Regulator", earning it a place in the Guinness Book of Records.

This one-off creation measures 2.20 m tall and weighs 12 tons. Its mechanical movement alone weighs 120 kg. This modern-day masterpiece required more than 2,800 hours of work and was unveiled at the Louvre in Paris, before touring Europe, the Middle East and the US.

2008
2009

Acquisition of the Manufacture
by Swiza SA

Swiza SA, which already owned Swiza 1904 and Matthew Norman, acquired the L'Epée brand. L'Epée and Swiza thus combined their expertise to form the only Swiss Manufacture specializing in quartz clocks and high-end mechanics. From design to assembly, the clocks are produced entirely in-house using internally machined and finished components thanks to the brand's internationally renowned expertise.

2010

The creation of
a new modern
collection

L'Epée 1839 went on to develop a collection of exceptional desk clocks, including a sophisticated range of classic carriage clocks, contemporary models (Le Duel) and minimalist avant-garde models (La Tour). The L'Epée creations feature complications

such as retrograde seconds, power-reserve indicators in the form of animated logos, perpetual calendars, tourbillons, chiming mechanisms and more, all designed and produced in-house. The very long power reserves and remarkable finishes of these creations have become brand signatures.



2014 175th anniversary
horological sculpture

In the wake of modern creations such as Le Duel and La Tour collections, L'Epée 1839 stole the headlines by unveiling its CREATIVE ART LINE and the Starfleet Machine, the first one of the collection.

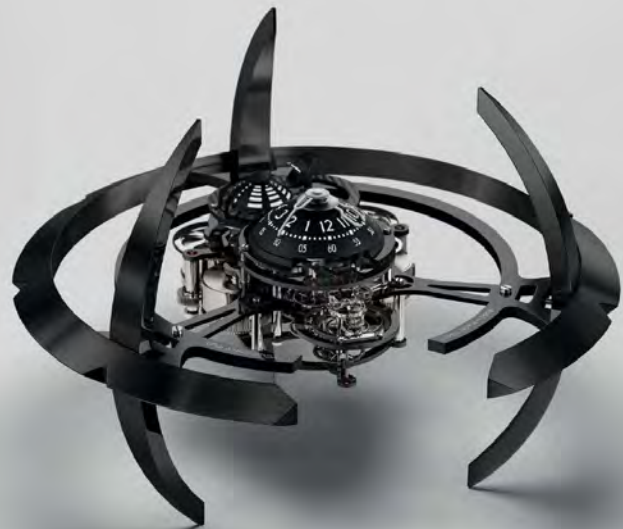

STARFLEET MACHINE
PHOTOGRAPHY

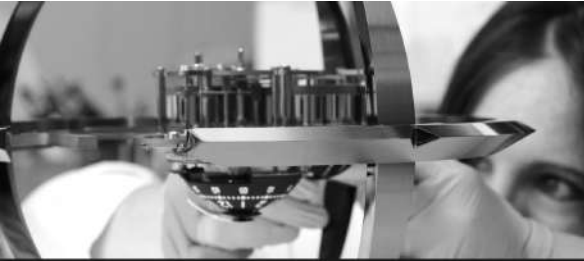

OUR VALUES

L'EPÉE 1839 IS A SWISS MANUFACTURE

SPECIALIZING IN THE DESIGN AND

PRODUCTION OF HIGH-END MECHANICAL

CLOCKS – AN ART IT HAS BEEN

PERPETUATING FOR OVER 180 YEARS.

THE L'EPÉE MANUFACTURE IS SITUATED

IN DELEMONT IN THE SWISS JURA. AND IS

CONTINUING ITS QUEST OF PERFECTION

AND ITS ENGAGEMENT TO SURPRISE WITH

ITS INCREDIBLE CREATIONS.

CLOCKMAKING EXPERTISE & PASSION

Specializing in horological complications for many years, L'Epée has built up an excellent reputation around the world. From computer-assisted design to the final technical checks and adjustments, all employees enthusiastically contribute to the creation of L'Epée timepieces. Their mastery of various tools and working methods has enabled the brand to adapt its complications in surprising ways: the transformation of the double retrograde into laser canon or blinking eyes respectively on The Starfleet Machine and Melchior Robot.

QUALITY

L'Epée is one of the few Manufactures to design, develop and produce its own timepieces. Armed with exceptional expertise, the L'Epée artisans and employees make it their duty to perpetuate the expertise inherent to the production of all its components, and to form partnerships with the best specialists in the artistic crafts whenever these are required for a creation. All L'Epée products bear the highly coveted "Swiss Made" label and are conform to all the new regulations associated with this label. They strive to maintain a continuously high level of excellence in order to meet the quality standards exacted by the brand's clientele of collectors and enthusiasts.

A BALANCE OF MODERNITY AND TRADITION

Drawing on its heritage, L'Epée has preserved its savoir-faire over the years, allowing it to create a world that combines modernity and clockmaking traditions. The brand's constant quest for innovative solutions and its unremitting desire to push back boundaries have enabled it to offer a varied collection of clocks that are both contemporary and extraordinary.

CUSTOMER SERVICE

The Manufacture's entire team is committed to satisfying its customers, and turning the dreams and wishes of these clock enthusiasts into reality. Passing on the brand's history and communicating its values through close customer relations is a priority.



L'EPÉE 1839
 X
 ECAL
 GEORG FOSTER

REFERENCES

74.6004/114

Silver

74.6004/134

Green

74.6004/144

Blue

74.6004/164

Red with white triangle

74.6004/184

White with blue stripes

74.6004/194

Blue with white stripes

74.6004/154

Yellow



TIME FAST D8

RACE CARS MEET SWISS WATCHMAKING

L'Épée 1839 takes us behind the wheel of the Time Fast. This vintage-inspired race car and a modern clock in one is a kinetic sculpture that tells the time. It was designed by Georg Foster, a promising young newcomer and major contributor to this second collaboration between ECAL (Ecole cantonale d'art de Lausanne) and the Swiss manufacture.

The piece features a number of eye-catching details, such as the long protruding engine hood, the typical 1950s radiator grill, the large spoked wheels, the driving seat positioned to the rear and the sloping back section. Its overall sporty feel is reinforced by its elegant design, flawless finishes and fluid lines.

The name of the Time Fast D8 clearly conveys its technical aspirations, incorporating a motor that can last 8 days—or rather an in-house caliber with a 192-hour power reserve beating at 18,000 vibrations per hour.

With 289 ultra-precise mechanical components finished with the greatest care, Time Fast promises its owner nothing but pure pleasure and sensations.

This kinetic sculpture displays the hours and minutes like a race number, allowing the time to be easily read on the side of the chassis. A figure sits in the cockpit, where a glass dome, or rather a driver's helmet, highlights the thrumming escapement. In front of him is the steering wheel, which adopts the three-spoke design typically seen in race cars, serving to set the time.

Measuring 38 cm long, 16 cm wide and 12 high and weighing just 4.7 kg, this race car is by no means lacking in stature and could easily have come straight from one of the greatest motorsports stables.

TIME FAST D8 IS ALIMITED EDITION:

100 PIECES PER BODY COLOR, INITIALLY PRODUCED IN RED, BLUE, GREEN, GREY, BLUE WITH WHITE STRIPES AND WHITE WITH BLUE STRIPES VERSIONS.

Meanwhile, in a subtle nod to childhood memories, the mechanical motor is wound just like a pull-back car.



TIME FAST D8



IN DETAILS

DESIGN & INSPIRATION

For all generations, classic 50s cars are firmly ingrained in the collective subconscious and imagination. Single-seaters boasting a sleek design, fluid lines and assertive aerodynamics, they fuel many a dream. Time Fast, which was designed by Georg Foster while he was a master's student at ECAL, draws inspiration from a dream of becoming a race driver, or simply the desire to experience the thrills of speed. To create this realistically proportioned mechanical sculpture, he drew on his childhood memories to add symbols and representations, such as boards, bodywork and steering wheels.

The shaping and production were entirely entrusted to the manufacture's passionate teams, predominantly comprised of automotive enthusiasts. With the exception of the raw aluminum casting, the crystals and the jewels, which are sourced from elsewhere, every piece has passed through the hands of the twenty or so experts within the L'Épée 1839 workshops.

THE CAR'S STRUCTURE

Just like a normal-sized car, Time Fast D8 is formed of solid aluminum body parts, as well as components as small as an escapement wheel (measuring just a few millimeters across). But here, each part is individually and impeccably finished, whether decorated, polished, satin finished or sand-blasted by hand. The movement's plates form the chassis.

Each has been designed with great attention to detail, symbolizing for instance the engine block of old race cars. As if to cool the motor constantly running at 18,000 vibrations per hour, the radiator grill is openworked to reveal the manufacturer's emblem. A dual exhaust provides one final nod to the automotive world.

Particular attention has been paid to the four wheels, whose spoked rims are wrapped in soft rubber for greater grip, providing excellent transmission of power during winding.



TECHNICAL SPECIFICATIONS

LIMITED EDITION

100 pieces per color

FUNCTIONS

Hour and minute display
Freely move forwards

POWER RESERVE

8 days

ENGINE

Tiered mechanical movement
L'Épée 1839 1855 MHD in-house caliber
Incabloc protection system
2.5 Hz
26 jewels

WINDING & TIME SETTING

Time set via counterclockwise rotation of the steering wheel
Reverse the car to fill it up (Carefully wind the movement like a pull-bar car)

DIMENSIONS

289 parts
Weight: 4.7kg
Dimensions:
38.5 cm long x 16 cm wide x 12 cm high

MATERIALS

Nickel- and palladium-plated brass, stainless steel
Blown glass dome
Front and rear bodywork in aluminum
Spoked rims in stainless steel
Tires in hard-wearing rubber

FINISHES

Polished and sand-blasted movement
Satin-finished struts
Polished and satin-finished rims
Painted bodywork (Automotive paint)



TIME FAST D8 IN DETAILS

AUTOMOTIVE AND HOROLOGICAL FUNCTIONS

In motor racing, it's well known that although the driver is the only one to be first over the finish line, his entire team helps to make this victory possible by achieving the impossible. What applies to the track also applies to life as a whole. The teams of designers, engineers and watchmakers therefore embraced the challenge of producing an exceptional and unique clock incorporating all the elements of a race car. Every detail has been carefully considered to intimately interlink form and function to spark a renewed fascination for kinetic sculptures.

THE ENGINE CONSISTS OF A TIRED MOVEMENT WITH AN 8-DAY POWER RESERVE THAT WAS ENTIRELY DEVELOPED TO HUG THE CURVES OF THE BODYWORK.

The hours and minutes are displayed on the side through an aperture resembling a typical competition number, via two engraved stainless steel disks. On the other side of the chassis is the advertising spot, the characteristic circle on iconic race cars, which can be optionally customized to create a personalized car, by means of an engraving, for example (the L'Épée 1839 logo comes as standard).

Time Fast D8 needs to be filled up (with mechanical energy) once every week. The mechanical movement's barrel is wound by moving the wheels in reverse to provide the car with the power it requires to remain fully functional. Meanwhile drive mode is simply designed to provide unimpeded delight.

In the cockpit, the car's steering wheel, which has been specially designed to incorporate the time-setting wheel, can be used to adjust the time if the engine ever breaks down. Located in the driver's seat, a counterclockwise adjustment adjusts the time, while clockwise adjustment can be used to reposition the steering wheel once the correct time is set.



GEORG FOSTER

DESIGNER / ECAL

Son of an engineer, Georg Foster (26) discovered a passion for mechanics at a young age. After studying design in London (London College of Communication and Central Saint Martins), Georg continued his professional development in the fields of furniture, jewelry and accessories, working in particular on artisanally produced motorbike helmets. This varied experience brought him closer to the world of luxury, know-how and high-precision work. In 2017, he enrolled in a Master of Advanced Studies in Design for Luxury and Craftmanship at ECAL (Ecole cantonale d'art de Lausanne).

During his studies, thanks to a partnership with L'Épée 1839, he was able to work on a project that combined two of his favorite disciplines: precision mechanics (watchmaking) and travel (Georg lived in several African countries, as well as Turkey and the UK before moving to Switzerland, where he is partly from).

His idea was to design a car, and more precisely a monocoque single-seater whose shape recalls the vehicles taking part in classic races since the very invention of the automobile.



L'ÉPÉE 1839
X
E C A L
GEORG FOSTER

TIME FAST CHROME

RACE CARS MEET SWISS WATCHMAKING

TIME FAST CHROME LIMITED EDITION OF 100 PIECES IN EACH COLOURS.

SILVER CHROME AND GOLD CHROME

L'Épée 1839 continues its Time Fast legacy with the creation of two new limited editions in Chrome!

They include the Silver Chrome Time Fast and the Gold Chrome Time Fast.

The Time Fast is a vintage-inspired 1950's F1 race car that is a kinetic sculpture and modern clock all in one.

The Time Fast was designed in collaboration with Georg Foster, ECAL (Ecole cantonale d'art de Lausanne) and L'Épée 1839.

The Time Fast features a number of eye-catching details from the 1950's F1 era. They include the long protruding engine hood, the iconic radiator grill, the large spoked wheels, the rear driving seat positioning and the sloping tail section. Its overall sporty feel is reinforced by its elegant design, flawless finishes, fluid lines and these two newly created Body Chrome Color's.



TECHNICAL SPECIFICATIONS

LIMITED EDITIONS

Time Fast is a Limited edition of 100 pieces per color.
Silver Chrome and Gold Chrome

FUNCTIONS

Hour and minutes display
Freely move forwards

POWER RESERVE

8 days

ENGINE

Tiered mechanical movement
L'Épée 1830 1855 MHD in-house caliber
Incabloc protecting system
2.7 Hz
26 Jewels

WINDING & SETTING

Time set via counterclock rotation of the steering wheel
The clock is wound using the rear wheels carefully wind the movement like a pull-back car

DIMENSIONS

289 parts
Weight: 4.7 kg
Dimensions:
38.5 cm long x 16 cm wide x 12 cm high

MATERIALS

Palladium-plated brass, polished stainless steel, Chrome deposition
Incabloc protection system
Blown glass dome

Front and rear bodywork in aluminum
Spoked rims in stainless steel
Tires in hard-wearing rubber

FINISHES

Polished and sand-blasted movement (plates and wheels) / Satin-finished struts (stringers) / Polished and satin-finished rims / Painted bodywork



DESIGN & INSPIRATION

For all generations, classic 50s cars are firmly ingrained in the collective subconscious and imagination. Single-seaters boasting a sleek design, fluid lines and assertive aerodynamics fuel many a dream.

The shaping and production of the Time Fast was entirely entrusted to the manufacture's passionate teams, predominantly comprised of automotive enthusiasts.

The name of the Time Fast clearly conveys its technical aspirations, incorporating a motor that has an 8 day power reserve—or rather an in-house caliber with a 192-hour power reserve beating at 18,000 vibrations per hour.

AUTOMOTIVE FUNCTIONS

In motor racing, it's well known that although the driver is the only one to be first over the finish line, his entire team helps to make this victory possible. What applies to the track also applies to life as a whole. The teams of designers, engineers and watchmakers therefore embraced the challenge of producing an exceptional and unique clock incorporating all the elements of a race car. Every detail has been carefully considered to intimately interlink form and function to spark a renewed fascination for kinetic sculptures.

The engine consists of a tiered movement with an 8-day power reserve that was entirely developed to hug the curves of the bodywork.

The hours and minutes are displayed on the side through an aperture resembling a typical competition number, via two engraved stainless steel disks. A figure sits in the cockpit, where a glass dome, or rather a driver's helmet, highlights the thrumming escapement. In front of him is the steering wheel, which adopts the three-spoke design typically seen in race cars, serving to set the time

On the other side of the chassis is the advertising spot, the characteristic circle on iconic race cars, which can be optionally customized to create a personalized car, by means of an engraving, for example (the L'Épée 1839 logo comes as standard).

In the cockpit, the car's steering wheel, which has been specially designed to incorporate the time-setting wheel, can be used to adjust the time if the engine ever breaks down. Located in the driver's seat, a counterclockwise adjustment adjusts the time, while clockwise adjustment can be used to reposition the steering wheel once the correct time is set.

Time Fast D8 needs to be filled up (with mechanical energy) once every week. The mechanical movement's barrel is wound by moving the wheels in reverse to provide the car with the power it requires to remain fully functional. Meanwhile driver mode is simply designed to provide unimpeded delight.



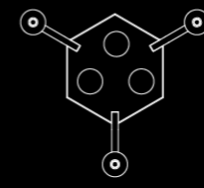

SPACE CLOCK

L'EPÉE'S SPACE CLOCK IS A HOROLOGICAL CALL TO INTERSTELLAR COOPERATION

SPACE CLOCK IS A LIMITED EDITION OF 100 PIECES IN EACH OF 3 CONFIGURATIONS:

Human to Human, Human to Alien, and Jet to Spaceship

Space Clock is a playful animated creation combining space exploration with the fundamental human need for connection! We have long been captivated by space exploration and boldly going where no man has gone before. It's a fascination encapsulated by L'Épée 1839's new Space Clock. Inspired in shape by the historic lunar landers from NASA, the Space Clock's aluminum body houses an eight-day movement driving a mechanical animation underneath the dome of the ship. Capturing the spirit of interplanetary adventure as a machine designed to fly among the stars, it also seeks to remind us all just how human we are.

The playful seesaw animation on the top of the fuselage depicts a scene of child-like innocence, two astronauts gleefully bouncing and spinning around, working together and having a blast. A different configuration finds an interspecies pair as an astronaut and alien face each other still another configuration depicts a flying saucer and fighter jet flying around under the dome. The figures seesaw back and forth every 20 seconds, while the entire seesaw completes one rotation every 10 minutes.

Underneath the main body are mounted three propulsion engines for manoeuvring off a new planet, an anemometer for taking measurements of the wind of any atmosphere, a satellite communications dish, and a symbol of human exploration, a flag.

The clock rests on three outrigger legs perfect for setting down in soft or rocky terrain, and the body has plenty of windows and portholes for observation as you explore space. Time setting and winding are accomplished via two portholes opposite the window into the beating heart of the caliber 1853.BAS.

Space is the ultimate adventure for humanity as we grow from our humble beginnings. But L'Épée 1839 wants us to retain that wonder and innocence of a child and remember we can accomplish great things. Space Clock proposes that ideal ambassadors in space or at home may just be the children we seek to emulate as they exhibit the best of human nature: curiosity, compassion, and wonder.



TECHNICAL SPECIFICATIONS

LIMITED EDITIONS

Space Clock is a Limited Edition of 100 pieces per configuration:

Human to Alien/Human to Human/Jet to Spaceship

FUNCTIONS

Digital hours and minutes are displayed on continuously rotating aluminum cylinders with engraved numerals and markings

Mechanical seesaw automaton displays rotating and oscillating figures underneath a glass dome

Time setting and winding is accomplished with a key via portholes on the side of the fuselage; time setting on the second level of the movement, winding on the lower

Number of components: 364

MOVEMENT

L'Épée 1839 caliber 1853.BAS designed and manufactured in-house

Multilevel vertical architecture

Balance frequency: 2.5 Hz / 18,000 vibrations/h
27 jewels

Incabloc shock protection system

Power reserve: 8 days, one barrel

MATERIALS & FINISHING

Palladium-plated brass

Stainless steel

Anodized aluminum

Finish: polished, satin brushed, sandblasted, anodized, palladium plating

DIMENSIONS & WEIGHT

257 mm diameter - 12 faces: 145 mm height;
281 mm total height
3.4 kg

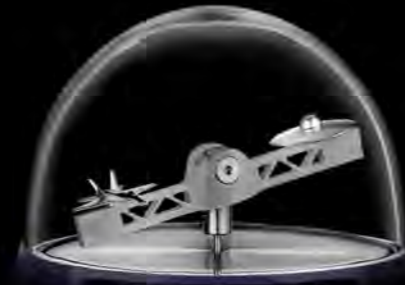

74.6008/144

HUMAN TO ALIEN



74.6008/204

JET TO SPACESHIP



74.6008/404

HUMAN TO HUMAN

DESIGN & INSPIRATION

Space Clock is a tribute to innocence and wonder, but it is also a mechanical tribute to space exploration. The entire lander body and leg structure are in aluminum - just like the actual lunar lander. To maintain lightness and portability it borrows from aerospace engineering and uses structural lightening in the outrigger legs, the seesaw structure, and the fuselage body.

The clock is very stable thanks to the large brass landing pads at the bottom of the outriggers, which are diamond polished and available in palladium or gold plating. The clock features a variety of finishes including satin blasted, polished, brushed, painted and anodized, as well as hand painting on the characters riding the seesaw. The astronauts, aliens, UFO, and fighter jets are all meticulously hand painted for added details.

The figures seesaw back and forth every 20 seconds taking 40 seconds for a full cycle. As the figures rise and fall thanks to their cooperation in play, the entire seesaw rotates counter-clockwise along a central axis, completing one rotation every 10 minutes.

Inside the fuselage is the custom 8-day caliber 1853.BAS designed to fit inside the Space Clock and developed to drive the mechanical seesaw animation.

Just below the upper observation deck, underneath a large mineral glass observation dome, where astronauts and aliens play together, the time is displayed on two anodized and laser engraved cylinders. The minutes pass by quickly on the top level while the hours creep by below. But when you are playing with a seesaw on a spaceship, time really flies when you are having fun.

Space Clock comes in three main configurations based on the figures highlighted under the dome. For international cooperation there is an animation with two astronauts of earth, for interstellar cooperation there is an animation with an astronaut and a space alien, and for those that love aerospace above all else, the final configuration sees a fighter jet and a UFO flying around the observation deck.

Space Clock celebrates adventure and cooperation, space is the final frontier where we must partner together to push the boundaries of human existence and understand we still are fragile creatures that thrive when we help each other. The child-like awe presented with such a playful animation beckons you to answer the call of a better humanity. It's out there waiting for us all!



L'ÉPÉE 1839



THE UNNAMED SOCIETY

GOLDEN BOY

A REIMAGINATION OF THE LEGENDARY WINCHESTER REPEATING RIFLE

Golden Boy is a new class of hyper-exclusive items that redefines the Art of Gifting and takes creativity, aesthetics and artisanship to the highest level.

Today, The partnership between L'Épée 1839 and The Unnamed Society opens another stunning creation imagined for those who set the bar for the Art of Gifting a bit higher than the rest, for appreciators of the finer things, and for visionary collectors.

Golden Boy remains true as ever to the spirit of "creating the impossible that defies the imagination" by looking not just at a timekeeper as an expression of aesthetic, engineering and artisanship excellence, but as a true witness of its time. Golden Boy is the logical sequel to Pancho Villa's Bisley Colt – an intricate work of artistry and precision that engages the imagination and the senses on many levels, taking us back to an age of human evolution that seems impossible in hindsight and yet epitomizes our understanding of courage, resilience and perseverance.

Golden Boy has the same dimensions as the original, the same feel and heft. Holding it is holding the legend. Beholding it is glimpsing the amazing era that defined adventure and fired the imagination of every generation born since.

The legend that won the West...

Nicknamed the 'Gun that Won the West,' the Winchester Rifle remains one of the most iconic firearms of all time. Used by both lawmen and outlaws in the Old West, the Winchester rifle so perfectly embodies the legendary struggle between the peacekeepers and the bandits. Favored by many notable figures such as Billy the Kid, Butch Cassidy, and Buffalo Bill it has become a symbol of that time.

For the gun that inspired Golden Boy, the year is 1866. The place: a vast country born less than a century before from the purest of desires, self-determination.

Winchester 'Yellow Boy' 1866 name: It wasn't the settlers or bandits who came up with the term 'Yellow Boy' as shorthand for their trusted rifle. 'Yellow Boy' was what the Indians said, when they saw the shiny brass-alloy receiver that housed the cocking and loading mechanism of the lever action rifle.

Historians all agree that the Winchester was a key element and so representation of winning battle.



TECHNICAL SPECIFICATIONS

LIMITED EDITION

UNIQUE PIECES

FUNCTIONS

Hour and minute display
A functional hammer and trigger as a playful function

POWER RESERVE

8 days

ENGINE

L'Épée 1839 in-house movement
Incabloc protection system
2.5 Hz / 18,000 vh
11 jewels
342 components

WINDING & TIME SETTING

Manual winding by swivel motion of the cocking mechanism of the lever action rifle - actioning the lever 15 times for a 8-day power reserve
Time setting by opening up the left side window and turning the disks manually

DIMENSIONS & WEIGHT

109.3 cm long x 5.7 cm wide x 20 cm high
5.4 kg

MATERIALS

Stainless steel
Brass

FINISHES

Polishing
Microblasting
Satin-finishing

Golden Boy is a work of art in form and function

A true-to-the-legend reimagining of the iconic lever action rifle as a clock, its original loading and cocking mechanism rethought for winding the timekeeping calibre and setting the time. Holding – and beholding – this uniquely fascinating feat of engineering and artisanship evokes childhood dreams of a far-away age that ultimately helped shape our modern times. It can be displayed to great effect both on a desk, mantelpiece or on the wall.

In a way no conventional clock could ever hope to, Golden Boy doesn't just tell time...

Inspiration

It is one thing to hold and handle Golden Boy, and feel transported into another age. The age of your own childhood, when playing the various roles that defined the conquest of the west – cowboy, Indian, soldier, settler – would first fill afternoons and then late night dreams. Golden Boy takes you there.

It is quite another to see Golden Boy displayed on its bespoke stand. Shock. Evoke. Inspire. These are the words that should describe a piece of Art. Shocking because so unusual. Evocative because of its power to rekindle powerful memories. Inspiring because it draws you into an unexpected juxtaposition of engineering and aesthetics, itself triggering new associations.

Indeed, if the bespoke display stand created especially for Golden Boy comes at no extra cost, it is because together they form a whole. Resting on its display on a desk, table or mantel, Golden Boy is an immediate presence in the room. When the display is placed on a wall, Golden Boy becomes a painting telling not just one story, but thousands. It has such an uncanny effect of transfiguring the setting in which it is displayed.

Design

Says Arnaud Nicolas, CEO of L'Épée: "Golden Boy is our second project with The Unnamed Society and a natural continuation of the Pancho Villa's Bisley Colt we created together. Bolting a clock to a gun was never an option, so rethinking the original rifle's ingenious lever action mechanism as a main component of the clock calibre seemed like an irresistible challenge. The result is a work of engineering that transcends its function into a work of art, true to our DNA.

What made the lever action repeating rifle such a gamechanger back in the day was the revolutionary approach to loading ammunition, cocking the hammer and chambering the bullet in one rapid, fluid motion – with a lever actioned by the trigger hand. Able to hold 15 rounds before having to reload, the original was not only much more practical than a single-shot rifle, but also allowed for excellent handling and accuracy.

L'Épée 1839 captures this defining movement of the hand as it loads the round and prepares the gun for firing: by having the clock mechanism wound – 'loaded' – in exactly the same way. By actioning the lever 15 times – as for the 15 bullets the 1866 Winchester magazin – the mechanism is fully wound for a 8-day power reserve.





L'EPÉE 1839



M B & F

ORB

MORE THAN MEETS THE EYE

At first glance, the Orb looks like a futuristic model of an eye with its perfectly formed shiny sphere, and its dial taking the place of the iris and the pupil. But nothing is ever quite what it seems with the collaborative clocks of L'Épée 1839 x MB&F.

The minimalistic structure is composed of four elytra (that's the technical word for a beetle's protective wing covers, in case you were wondering) that not only open up, but can also swivel like a transformer to display the Orb in a variety of different positions. The shiny-white version is reminiscent of the first iPods with their lustrous curved cases, a surface that is particularly pleasing to the eye and the touch.

The possibilities of displaying the ORB are multiple. Placed on its saucer so it doesn't roll away, it can be displayed completely closed or with one, two or three opened elytra. Alternatively, opening all four elytra allows to display the clock without the saucer.

Orb starts life as a solid block of aluminium that is then hollowed to create the perfect sphere. Once cut, the elytra are then coated with several layers of lacquer that are hardened in a kiln to create the brilliant finish. The four elytra are soldered to the structure with torque hinges so they can retain their angle however little or wide they are opened. When closed, the elytra are held in place with four tiny magnets on the interior of each tip to keep the shape of a perfect sphere.

Powering this state-of-the-art clock is a beautiful L'Épée 1839 hour-striking movement with an eight-day power reserve. In contrast to other clocks, the movement is not perceivable from the outside. But the perfectly formed sphere invites the viewer into the mechanical heart of the piece and the discovery of the movement.

The eight-day calibre can be seen just slightly through the curved aluminium dial covered by a domed mineral glass, which has a hole in the centre to allow the setting of the time with a special key.

There are two barrels, one for the time and the other for the striking of the hours, that are wound separately. The hour mechanism doesn't just chime the passage of the hour, but indicates the actual hour, like a church clock. This function can also be repeated on demand via a button on the side of the clock, or turned on and off if required.

This new hour-striking development is based on a similar mechanism used in L'Épée 1839's historic carriage clocks. In France, these are known as "Officer's clocks" as legend has it that when Napoleon almost lost a battle because one of his officers was late, he ordered all of his military chiefs to carry a carriage clock with them at all times.

INSPIRATION

The idea behind the Orb is the brainchild of German designer Maximilian Maertens, who started his artistic career at MB&F as an intern before setting up his own design studio in Berlin. Maertens worked with MB&F and L'Épée on the T-Rex clock, before being given free rein to create the TriPod and now the Orb.

REALISATION

While Maximilian Maertens and MB&F came up with the concept and design of the Orb, it was L'Épée 1839, Switzerland's premier clock maker, that developed the movement as well as the lacquered transformable sphere. L'Épée produces all the components, except for the mineral glass and the rubies, puts them all together and regulates the high precision, eight-day movement.

While nothing about this atypical project was easy, L'Épée faced two major challenges. The first was making the sphere in four pieces so that they could be totally transformable, durable, and also form a perfect sphere when closed.

The second significant challenge was developing the striking system. Usually, with a bell-chiming mechanism, gravity is needed to strike the bell. As the Orb's brass bell can find itself in an infinite number of different positions, L'Épée 1839's clockmakers incorporated several springs to strike the bell so it can chime even when it is flat. The system is a hybrid between a clock and a watch striking mechanism.

ORB

The word orb comes from the Latin orbis, meaning "circle" or "disk". The word is also the basis of the word "orbit", a word that has stayed in the modern-day vernacular even if orbits are now known to be elliptical and not at all round.

Orbs are also used today in fanfiction to mean eyes, as in "cerulean orbs" that designate blue eyes or "chocolate orbs" for brown eyes – a nod to perhaps the first thing that comes to mind when we first lay eyes on the Orb.



Available in white or black, the Orb won't be able to accompany its owners out into the field, but with its hourly striking mechanism, it is a beautiful reminder of the time as it passes for all desk warriors!





TECHNICAL SPECIFICATIONS

LIMITED EDITION

50 pieces per color

FUNCTIONS

Hour and minute display
Hour and half-hour Strike

POWER RESERVE

8 days

ENGINE

L'Épée 1839 in-house movement
Incabloc shock protection system
2.5 Hz / 18,000 bph

Jewels: 17

Total components: 300

WINDING & TIME SETTING

Manual winding by double-depth square socket key
that sets time and winds movement

DIMENSIONS

Weight : 1.9 kg

Dimensions

Closed (body) : 17 cm high x 17 cm diameter

Complete opened : 24 cm high x 30 cm diameter

MATERIALS

Palladium-plated brass and stainless steel
Elytra in aluminum and covered with handmade
lacquer

FINISHES

Polishing, sand-blasting, satin-finishing





TIME FLIES

ALLOW YOUR IMAGINATIONS TO SOAR THROUGH THE SKIES

Who never had a childhood dream of adventure as a pilot ?
In collaboration with ECAL and Juliette Lefèvre, L'Épée 1839 pays tribute to one of the most brilliant inventions ever made

Aviation made its mark on the last century, motivating adventurers to go ever higher and ever further, and it changed traveling forever. The plane captured the collective imagination, and there have been many stories of heroic aircraft journeys.

Some things fire up imagination and fantasy more than others. Some adventures only the elite, can enjoy, but the boundless expanse of the imaginary world is accessible to everyone. Time Flies is an 8-day clock in the form of a stylized 1930s plane, offering just enough structure to provide form, and just enough empty space to inspire our imaginations.

Hours and minutes are displayed on large diameter stainless steel disks with black PVD coating on a circular-brushed satin finish and stamped numerals. A quick glance is enough to read the time thanks to the excellent legibility of its display, but the spectacular, skeletonized movement is worthy of deeper contemplation. The movement, built specifically for this Time Flies, allows the escapement, which regulates precision, to be displayed in the cockpit. Accuracy is in the pilot's seat!

The architecture of the 8-day movement, developed in-house by L'Épée 1839, follows the form of a real airplane. As in a plane,

power comes from the front where the engine is located, and is generated by a fully openworked crown reminiscent of engine cooling radiators just behind the propeller. When fully wound Time Flies can soar for a full eight days before "refueling."

An airplane's control and instrumentation systems are located within the cockpit; and the same is true for Time Flies, which has a horizontal precision regulator in its cockpit, just above the wings. The constantly oscillating balance-wheel of the regulator draws the eye, and is protected from both cosmic radiation and curious fingers by a series of small panels forming the cockpit's cage.

In another nod to childhood toys and fantasies, the propeller spins freely at a simple push of the finger. Despite of its airy skeleton, Time Flies weighs a substantial three kilograms, its three-wheel landing train providing excellent stability.

For a truly sensational display, L'Épée 1839 has developed a mounting stand on which Time Flies can be admired taking-off. An innovative latch beneath the movement clips it securely in place. On its stand Time Flies is as elegant placed on your desk as on its pedestal in a library.

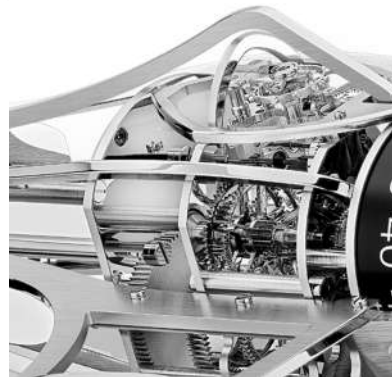



TECHNICAL SPECIFICATIONS

LIMITED EDITION

99 pieces per color

FUNCTIONS

Hour and minute display

POWER RESERVE

8 days

ENGINE

L'Épée 1839 in-house movement

Incabloc protection system

2.5 Hz / 18,000 v/h

22 Jewels

370 components

WINDING & TIME SETTING

Manual winding and time setting by counterclockwise rotation of the engine's radiator at the front of the clock, behind the propeller

DIMENSIONS & WEIGHT

35.4 cm long x 44.2 cm wide x 13.7 cm high

3 kg

MATERIALS

Stainless steel

Brass

FINISHES

Polishing

Microblasting

Satin-finishing

History, design & inspiration

L'Épée 1839 takes off once again in the conquest of the air, accomplishing one of humankind's wildest dreams. For centuries, man has dreamed of being able to take to the air and fly like a bird. From Leonard de Vinci's day to ours, geniuses and aeronauts developed aviation, pushing back its limits again and again, repeatedly challenging the laws of physics and daring to achieve the impossible.

Aviation was the theater of many exploits. In 1909, after 32 attempts, pilot Louis Blériot made the first crossing of the English Channel (40 kilometers between Calais and Dover). This feat of perseverance had a global impact, and pilots like Blériot, these "magnificent men in their flying machines," caught the world's imagination. Louis Blériot, always the pioneer, invested all his savings in his own aircraft factory. During the same period, Louis Charles Bréguet, a descendant of the watchmaker and physicist Abraham Louis Breguet, was another of the first aircraft manufacturers.

Breguet and Blériot are the founding fathers of commercial aviation. Blériot was the first to design aircraft for serial production, which notably saw service in the famous company Aéropostale.

Flying great distances in all weather conditions presented formidable challenges for these early aviators. Postal aviation would never have existed without the courage of its first pilots, true heroes who inspired future generations. Every flight was a high-risk adventure, embarked upon with no instruments or aids but the eyes and tenacity of its pilots.

These extraordinary pilots were models of courage and determination, traveling endlessly, living a life of adventure between earth and sky, triumphing over oceans, African deserts, and mountain chains. The Aéropostale adventure was fascinating and impressive — and because it was brimming with mechanical marvels and technological triumphs, it demanded audacity and sacrifice of its pilots.





L'Épée 1839 and aviation, a long story

Aeronautical research was in constant development in a quest for new exploits and records. As early as 1921, Louis Charles Breguet believed it was possible to reach the speed of sound. In 1964, research began on designing the first supersonic airplane capable of transporting passengers. 1977 heralded the introduction of Concorde's Paris-New York scheduled passenger service.

TIME FLIES is a return to its origins for L'Épée, which, in providing the dock for the Concorde, is the only horological manufacture to have equipped a commercial supersonic aircraft.

Aviation and horological functions

Aviation and horology have been closely linked throughout their history. The earliest aviators used their watches as their sole navigational instrument to calculate their position and set their course.

Juliette Lefèvre, designer x ECAL

Born in France, Juliette Lefèvre is a passionate and eclectic designer drawing inspiration for her creations from travel and discovery. After obtaining her science Baccalauréat, Juliette Lefèvre retained her love of the sciences and the magic of mathematics, revealing her Cartesian side in her artistic projects. Her artistic research led her to Penninghen and the Ecole Supérieure des Arts Graphiques in Paris

(formerly the Académie Julian, where the Nabis movement emerged 1888, including such great names as Jean Dubuffet, Marcel Duchamp, Jacques Villon, Édouard Vuillard, and Henri Matisse). She spent five years completing a Master's degree in artistic direction. Juliette Lefèvre career encompassed the creative studio of Chanel, bringing color, travel, and artistic direction input to the pop-up stores in Tokyo, Singapore, and Madrid. She then resumed her studies, completing a Master of Advanced Studies in Design for Luxury and Craftsmanship at the ECAL (Ecole cantonale d'art de Lausanne). This proved to be a valuable year of new contacts, new subjects, and the discovery of a new artistic avenue. The collaboration with L'Épée 1839 was her first design project, which proved to be a project full of complexity and a highly stimulating challenge. Today, Juliette Lefèvre continues to apply her talent to the world of luxury and the artistic crafts to exalt expertise.



PISTOL

L'EPÉE 1839



THE UNNAMED SOCIETY

L'Épée 1839, with its new and latest partner, The Unnamed Society, whose motto is « Create the impossible that cannot be imagined », is facing a new creative, aesthetic and philosophical challenge by exploring an emerging clock concept: A Bisley pistol inspired clock.

This timeless and unique masterpiece has not only succeeded in flawlessly combining elegance and practicality but also owns a rich story behind:

Icon of the Mexican revolution, Pancho Villa has been captured many times with his rotating cannon Colt Bisley; as a revolver, it stands for an intricate mechanism with an aura of danger. As Pancho Villa's revolver, it stands for the power of revolution, and every revolution is founded on values.

The combination of a pistol and time rightly symbolizes the preciousness of every moment and the speed at which it can be stolen. In this glorious creation, 'Pistol' wonderfully beautifies the time through a seductive design and by means of a fascinating technical development.

Holding a power reserve of 8 days and fitted with a singular butt, 'Pistol' is set with a canon that will be used as the rewinding point for the movement – as the owner cleans their gun each week – a functional hammer and trigger – mixing form and function has always been part of L'Épée DNA – a barrel for the hours and minutes who can be set directly, such as a sniper checking the free rotation of the barrel...



CUSTOM OPTIONS

Some aesthetic features have been kept (barrels, handlebar, trigger guard)

Grip Options: Animal's skin, horn, bones...Wood, precious metal, stones/diamonds...

Frame options: Engraved and/or set with stones/diamonds, solid precious metal...

Barrel options: Engraved and/or set with stones/diamonds, solid precious metal...

TECHNICAL SPECIFICATIONS

LIMITED EDITION

Pistol is produced in a limited edition of 50 unique pieces

FUNCTIONS

Hour and minute display
Freely moveforwards

POWER RESERVE

8 days

MOVEMENT

L'Épée 1839 in-house caliber
Frequency : 18,000 vph / 2.5 Hz
Jewels : 17

WINDING & TIME SETTING

The clock is wound by inserting the key into the barrel and spinning it
Time is directly set by rotating the minutes disc

DIMENSIONS

350mm long x 172mm large, base : 60.5mm diameter

Weight : gun : 2 kg + base : 1.3 kg

MATERIALS

Palladium plated Brass, Stainless steel

FINISHES

Satin-finishing, Polishing, Sand-blasting, Laser engraving

L'ÉPÉE 1839



MB&F

TRIPOD

WELCOME TO ROBOCREATURES ERA

"Art begets art", American author Susan Vreeland once famously said. And this is certainly true in the case of TriPod, the 13th collaboration between L'Épée 1839 and MB&F.

TriPod comprises a minimalist clock face suspended between three delicate insect-like legs. It follows the mighty T-Rex what will become a trilogy of half animal/half robot creations that we called Robocreations. TriPod's name originates in the trios that inform it: three legs, three insect-eye spheres, and three movement levels comprising the creature's mechanical body.

Also, TriPod is the second in a group of three clocks set to form a trio. In the same way that H.R. Giger created his Alien universe, we're creating our own world of creatures.

Robocreations could well be future time capsules, fossilised "life" from a prehistoric era. With TriPod, Berlin-based designer Maertens, L'Épée CEO Arnaud Nicolas and Maximilian Büsser lead us into a horological post-modern prehistoric era.

TriPod features three delicate legs supporting a colourful body, three insect-eye spheres made of precision lens-quality glass and a clock dial making one full revolution in 36 hours that indicates three sets of hours and minutes. Underneath the dial is a 182-component three-dimensional sculptural movement crafted on three levels by L'Épée 1839 with a vertical balance slowly beating at a traditional 2.5Hz (18,000vph). Time-setting

and winding are by key, and when fully wound the movement offers a generous eight-day power reserve.

An essential element of TriPod is indicating the time, which is done by looking down on the dial composed of rotating disks. But this clock requires some interaction between Man and Machine: the observer reads the time thanks to three optical spheres, each magnifying the clock's numerals and making them legible.

To allow all three of the "insect eyes" to show the time from any angle, the dial features three sets of numerals 1-12, meaning that the dial completes a full rotation in 36 hours instead of the customary 12 hours. The time is visible through one of the magnifying lenses at any time.

"These clocks are our companions", says Büsser. "They live. They tick. They're like a pet – bringing life into your interior". Jurassic Park also famously gave us life where there wasn't... but what came after the dinosaurs? The trio of Robocreations rovides one imaginative possibility.





TECHNICAL SPECIFICATIONS

LIMITED EDITIONS

50 pieces per colour

FUNCTIONS

Hour and minute display
Animation of a full dial rotation in 36 hours

WINDING & TIME SETTING

Double-ended key to set time and wind the movement

MOVEMENT

Single barrel
21 jewels
182 components
2,5 Hz

POWER RESERVE

8 days

MATERIALS

Plated brass and optical mineral glass

DIMENSIONS & WEIGHT

26 cm high x 30 cm diameter
2,8 kg

The Inspiration

Young designer Maertens was the creative incubator for TriPod, during his internship at MB&F. The 1993 film Jurassic Park was a big influence on Maertens as it was the first movie he remembers watching as a child. While Maertens' inspiration from his childhood memory was first realized in MB&F's T-Rex, the first clock in the Robocreature trilogy, it's been a gift that keeps on giving. Which is apt as the entire premise of all of MB&F's mechanical masterpieces is to foster children's dreams as a creative adult.

When designing T-Rex, Maertens imagined a backstory to guide his development process to create a coherent balance of mechanical and organic visual elements. That story grew from elements in MB&F's past projects that included a starship pilot discovering new planets. As Maertens uncovered further inspiration from his love of Jurassic Park, a new story began to unfold that is now the backbone of the Robocreature trilogy.

TriPod represents how time originates for Jurassic Park. "This insect is the transition between dinosaur and what comes next because they're all still here", says Maertens.

While the primary inspiration for TriPod is the mosquito caught in amber that provides the DNA to genetically craft new dinosaurs, for the clock's look Maertens decided to emulate a water strider (Gerridae), an insect able to walk on the surface of water using surface tension and its long, slender, hydrophobic legs to distribute its weight over a large surface area.

"It feels much like a levitating insect walking over the water," Maertens explains, "and this inspired me to create something that looks very delicate. This is a direction I like to go, even if it caused some strife with the engineers over issues like stability". TriPod's three long legs make it seem too fragile to be true, but the balance is so perfectly calculated that the entire creation comes across as elegantly as the insect it's modelled after.

Movement and body

As a sculptural clock, an essential element of TriPod is indicating the time, which is done by looking down on the dial composed of two concentric, rotating disks. The outer disk displays the hour while the inner disk displays the minutes in increments of 15. Reading the time requires interaction between Man and Machine: the observer reads the time thanks to three optical spheres, each magnifying the clock's numerals and making them legible.

To allow all three of the "insect eyes" to show the time from any angle, the dial features three sets of numerals 1-12, meaning that the dial completes a full rotation in 36 hours instead of the customary 12 hours. The time is visible through one of the magnifying lenses at any time as well as the dial from above (albeit much smaller).

The spheres are suspended by brass "arms" cradling them like hands so as not to disturb their perfectly round shape or scratch them. Nicolas explains that manufacturing these cradles for the lens spheres was difficult to do in one piece, which was necessary to maximise stability.





L'ÉPÉE 1839



M B & F

DESTINATION MOON

SPACE ISN'T EMPTY, IT'S FILLED BY IMAGINATION

Reality sucks! In the 1960s, science fiction had us flying through the air on hoverboards and our imaginations soared, but we ended up with non-hovering boards with wheels on solid ground. Science fiction promised us 3D TV and engineers delivered, but we took one look, felt queasy and out they went. Science fiction filled our imaginations with elegant ovoid-shaped rockets that would fly us to the moon and beyond. Again engineers delivered, but the rockets, although eminently practical, ended up being straight, uninspiring cylinders.

Some things are best left to the imagination and Destination Moon does just that. It delivers just enough engineering for an eight-day clock looking like an exciting science fiction rocket from the 1960s, but with plentiful empty space allowing our imaginations to fill in the details.

Conceived by MB&F and built by L'Épée 1839, Switzerland's premier clock maker, Destination Moon is the quintessential torpedo-shaped rocket of childhood dreams. But look more closely and you will see that its minimalistic form is evocative rather than definitive.

Hours and minutes are displayed on large diameter stainless steel discs with stamped numerals. While the legibility of the time display is not in question, focusing on the time rather than the spectacular, vertically-structured, open movement is likely to require deep concentration.

Developed specifically for Destination Moon, the architecture of L'Épée's eight-day movement follows the basic design of a real spaceship. Power in a rocket comes from its base; the power for Destination Moon comes from the oversized winding crown in its base. The management and control systems of a rocket are above the power source; the same holds true for Destination Moon, which has a vertical regulator controlling precision below the time display, as well as a time-setting knob at the top of the movement. That eye-catching regulator with its animated balance is protected from cosmic radiation (and curious fingers) by a small panel of virtually invisible mineral glass.

In a further tip of the hat to childhood toys and fantasies, the horizontal circular plates in Destination Moon's movement are perforated like Meccano components. Despite its ethereal openwork construction, at four kilograms (nine pounds) Destination Moon is no lightweight: its solid landing pods ensure that it will not easily be knocked off course (or knocked over).



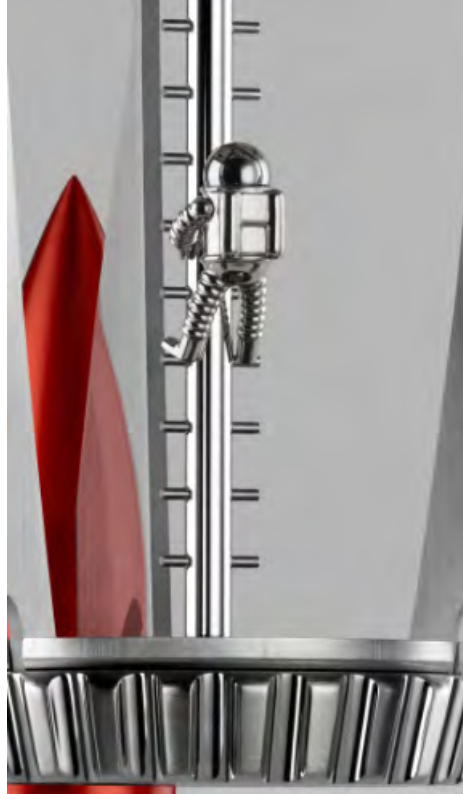

TECHNICAL SPECIFICATIONS

LIMITED EDITIONS

50 pieces

FUNCTIONS

Hour and minute display

WINDING & TIME SETTING

Manual winding by rotating the propulsion wheel at the base of the rocket
Time-setting knob at the top of the movement, above the indication rings

MOVEMENT

Single barrel
17 Jewels
237 components
2,5 Hz

POWER RESERVE

8 days

MATERIALS

Palladium-plated brass, stainless steel
and nickel-plated stainless steel

FINISHINGS

Polishing, bead-blasting and satin-finish

DIMENSIONS & WEIGHT

41,4 cm high x 23,3 cm diameter
4 kg

Inspiration

Destination Moon is a true collaboration between L'Épée 1839 and MB&F; driven by passion, the base concept was thought with the idea for the movement's distinctive vertical architecture.

The real magic of Destination Moon is space; not the space of the cosmos above our heads, but the largely empty space that is Destination Moon. If the body of the rocket was completely covered, observers would see the rocket of somebody else's youth, but because the rocket-themed desktop clock is in reality a largely empty, perforated frame, those viewing Destination Moon are each likely to see a slightly different spacecraft: the rocket of their own childhood rather than somebody else's... Space isn't empty; it's filled by imagination.

Realisation

While designed by MB&F, Destination Moon was constructed by L'Épée 1839, Switzerland's premier producer of high-end clocks. The concentric vertical construction of the eight-day movement was developed especially for Destination Moon.

And then there's Neil: a smile-inducing, space-suited figurine forged in solid silver and stainless steel, magnetically attached to the ladder connecting the crown to the movement. Neil is the astronaut flying Destination Moon to exotic worlds, but more importantly, Neil imparts a childlike sense of wonder by putting man into the machine. It brings a playful human element to the engineering of the Meccano-style openwork of the spaceship and its clockwork. Neil magnetically attaches anywhere along Destination Moon's boarding ladder. Whether he is embarking to take off for an adventure in space, or disembarking for an adventure on the moon's surface is up to the individual viewer's imagination.

Clockwork

Power for Destination Moon comes from the massive crown in its base, which transfers power to the mainspring barrel via the boarding ladder. The eye-catching regulator is vertically positioned to allow for maximum appreciation and protected from curious fingers behind a panel of mineral glass.

Two stainless steel discs with stamped white numerals respectively indicate the hours (top) and minutes as they line up with the streamlined double-ended pointer above the regulator. The time is set by a central knob in at the very top of the movement.

The stability of the clock is ensured by the substantial weight of Destination Moon's three landing pods.





L'EPÉE 1839



M B & F

STARFLEET EXPLORER

Six years after the launch of the Starfleet Machine, the first clock co-created by MB&F and L'Épée 1839, a new expedition is underway. The space station returns in 2020, in a more compact size and enhanced with bright colours, accompanied by a fleet of three small spacecraft exploring the universe; it rightfully bears the name of Starfleet Explorer.

Designed by MB&F, the Starfleet Explorer is an intergalactic spaceship-cum-table clock crafted by L'Épée 1839, the last remaining Swiss manufacture specialised in high-end table clocks. Not only does it display the hours and minutes, it also features an animation in which three spacecraft perform a five-minute orbit of the station. The highly visible, superlatively finished in-house movement boasts an exceptional eight-day power reserve. The mechanism can be manually wound using a double-ended key serving to wind the movement as well as to set the time.

Hours and minutes are indicated by means of two discs, along with an aperture and a brightly-coloured hand. More specifically, the minutes on a revolving radar dish are read off when they appear through the centre of a fixed metal aperture, satin-brushed by hand and anodised, that follows the dome's curved contours.

The hours disc placed just below remains motionless. An hour hand – likewise satin-brushed and anodised – indicates the hour by spinning in its place and performing a complete turn around the disc in 12 hours.

Starfleet Explorer also features a significantly original new element in the form of three tiny spacecraft, lined up along the same axis at regular intervals and placed inside the actual Starfleet movement, the heart of the mechanism, around which they revolve at a rate of one full turn every five minutes: a space exploration guided by the mothership.

The Starfleet Explorer's movement is placed horizontally, but its escapement is vertically positioned. The impeccably finished stainless steel or palladium-treated brass components (with the exception of the 11 jewels) are designed and manufactured in the L'Épée 1839 Swiss atelier. The gears and mainspring barrel are on full display thanks to the skeletonised mainplate and concentric C-shaped external structure. The Starfleet Explorer can rest on both ends of its vertical landing gear; a useful feature when turning it over to wind the mainspring and set the time. It can also be leaned sideways so as to offer a different view of the intergalactic horological station.

The Starfleet Explorer is a table clock, featuring essentially the same mechanisms as a wristwatch, only larger: gear train, mainspring barrel, balance wheel, escape wheel and pallet-lever. L'Épée 1839's regulator also features an Incabloc shock protection system, something generally only seen in wristwatches, which minimises the risk of damage when the clock is being transported.

The details of the polished movement can be fully appreciated by the naked eye, thanks in large part to the Starfleet Explorer's extremely open concentric C-shaped external structure, to which the mainplate is attached.

Starfleet Explorer is launched as three limited editions of 99 pieces each in blue, green and red





The outermost C-shape features three vertical arcs on which the clock rests. These graceful supports play a role in the design of the model, but also have a very practical application: to enable the Starfleet Explorer to be placed upside down for time-setting and rewinding using a special key.

One might be tempted to think that the more substantial size of the components simplifies work. Larger components, however, make finely finishing the movement much more difficult to handle than finishing a wristwatch, because of the bigger surface areas.

FORM FOLLOWS FUNCTION

The details of the polished movement can be fully appreciated by the naked eye, thanks in large part to the Starfleet Explorer's extremely open concentric C-shaped external structure, to which the mainplate is attached.

The outermost C-shape features three vertical arcs on which the clock rests. These graceful supports play a role in the design of the model, but also have a very practical application: to enable the Starfleet Explorer to be placed upside down for time-setting and rewinding using a special key.

TECHNICAL SPECIFICATIONS

LIMITED EDITIONS

99 per configuration

FUNCTIONS

Hour and minute display

WINDING & TIME SETTING

Double-ended key to set time and wind the movement

MOVEMENT

Single barrel
11 Jewels
185 components
18,000 vph / 2,5 Hz

POWER RESERVE

8 days

MATERIALS

Stainless steel for the main structure
hand-lacquered polymer for the three spacecrafts

DIMENSIONS & WEIGHT

11 cm high x 16,5 cm diameter
2 kg





TECHNICAL SPECIFICATIONS

LIMITED EDITIONS

100 per configuration

FUNCTIONS

Hour and minute display

WINDING & TIME SETTING

Wound by a key at the back of the movement
Time setting at the centre of the Murano glass dial

MOVEMENT

Single barrel
17 Jewels
201 components
2,5 Hz

POWER RESERVE

8 days

MATERIALS

Palladium-plated brass, stainless steel and bronze

FINISHINGS

Polishing, sand-blasting, satin-finishing

DIMENSIONS & WEIGHT

25,8 cm wide x 17,8 cm deep x 26,5 cm high
2 kg

L'ÉPÉE 1839



MB & F

T-R EX

JURASSIC ART

They say that art begets more art; that the act of creativity continues to generate and inspire other creations in turn. This is certainly true in the case of T-Rex, the 11th collaboration between MB&F and Switzerland's premier clockmaker L'Épée 1839.

The inspiration

Powerful and otherworldly, T-Rex was nevertheless drawn from a source both whimsical yet familiar. A quirky ornament on the desk of MB&F founder Maximilian Büsser, composed of a Christmas bauble perched atop two chicken legs. Members of the avian species are said to be modern-day descendants of the mighty dinosaurs of old, but the comic air of T-Rex's inspiration had a long way to evolve before it came to fruition.

Designer Maximilian Maertens was the creative incubator for the eventual rise of T-Rex as the 11th collaboration between MB&F and L'Épée 1839. The 1993 film *Jurassic Park* was a big influence on Maertens, being the first movie he remembered watching as a child. Said Maertens, "I just had the idea to do something with dinosaurs, and Max (Büsser) was very interested in biomechanical designs at the time, so we melded these two sources around his little desk sculpture and took the next step."

T-Rex is closely modelled on the actual skeleton of a Tyrannosaurus Rex, with Maertens studying 3D scans of dinosaur fossils to inject authenticity into the proportions and positioning of T-Rex's legs.

The structure

T-Rex is powered by a 138-component movement, designed and produced in house by L'Épée 1839, and finished to the very highest standards of traditional Swiss clockmaking. At the very top of the hand-wound movement, clearly visible through the skeletonised clock body surrounding it, is a balance beating at 2.5Hz (18,000vph). The eight-day power reserve is rewound directly via the barrel axis positioned at the back of the movement, while time is set through the centre of the dial. Both actions are taken with the same key.

Hand-blown Murano glass forms the clock dial of T-Rex, a material that both MB&F and L'Épée 1839 became thoroughly familiar with in the course of creating Medusa, their 10th collaboration. T-Rex comes in variations of green, deep blue and red Murano glass dials, which are vividly coloured with metallic salts via age-old techniques of glassblowing. The 30-cm tall T-Rex is made of stainless steel and palladium-plated brass and bronze, weighing approximately 2kg distributed over two finely sculpted feet.



A minimalist clock-face of Murano glass and steel, suspended between two jointed legs that end in taloned feet — T-Rex bears slight physical resemblance to the eponymous king of beasts. The name owes more to the aspects of design that reveal themselves to the close observer, such as the confluence of power and presence conveyed in the taut limbs. The literal time capsule formed by the spherical, skeletonised body is a subliminal yet insistent allusion to the fossilised bones that contain all we know of a prehistoric era. A minimalist clock-face of Murano glass and steel, suspended between two jointed legs that end in taloned feet — T-Rex bears slight physical resemblance to the eponymous king of beasts. The name owes more to the aspects of design that reveal themselves to the close observer, such as the confluence of power and presence conveyed in the taut limbs. The literal time capsule formed by the spherical, skeletonised body is a subliminal yet insistent allusion to the fossilised bones that contain all we know of a prehistoric era.

The legs of T-Rex are modelled directly on actual Tyrannosaurus Rex bones, using 3D scans of fossilised dinosaur skeletons as references to create verisimilitude in the final design. Alternating polished and sandblasted segments allow light to interact with the legs in such a way that make T-Rex seem agile and coiled to move, although the entire clock itself weighs approximately 2kg and its joints are fixed in place for stability.

Two slim steel hands arch outwards from the centre of the Murano glass dial, indicating the hours and minutes. Behind the dial is a 138-component movement by L'Épée 1839, crowned by a balance beating at the rate of 2.5Hz (18,000vph). The clock is wound with a key at the back of the movement for a maximum power reserve of eight days, while time-setting is accomplished at the centre of the dial with the same key.

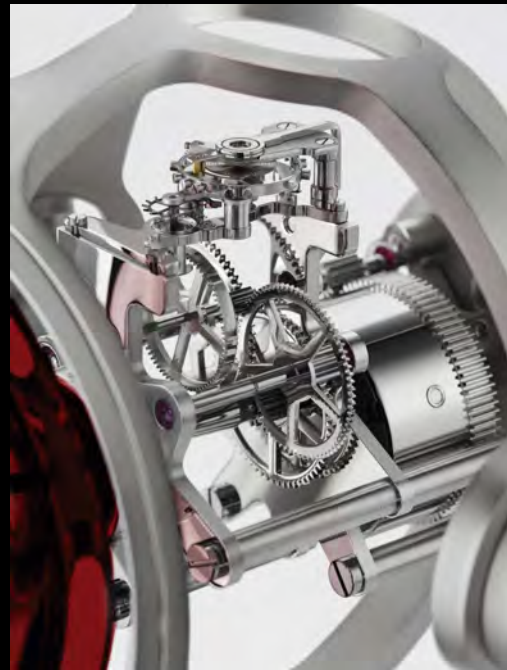

MEDUSA

A TRANSFIXING EXPRESSION OF TIME

Let's plunge into warm ocean waters where the beautiful and ancient jellyfish proliferate. Medusa is a dual-configuration clock, housed in hand-blown Murano glass, that can be ceiling mounted or stood upon a desk. In the form of one of the most compelling yet mysterious creatures of the sea, Medusa blends exceptional artisanal skill with Swiss horological precision, and introduces new frontiers in both.

The central mass of Medusa is formed by a large transparent dome of hand-blown Murano glass that evokes the bell-shaped body of a mature jellyfish. Two rotating rings, one displaying the hours and the other displaying the minutes, are visible through the dome, and the time is read off a single fixed indicator that extends over the rings. Like a jellyfish glowing in the abyss, Medusa glows in the dark thanks to Super-LumiNova. A 2.5Hz (18,000vph) movement beats underneath the time indication, forming the pulsating

heart of this mechanical creature. The movement of Medusa is entirely new and required over two years of development by L'Épée 1839. Whereas the other co-creations had separate points of winding and setting, Medusa required a combined system for winding and setting, since the surrounding glass dome limits access to the movement. Furthermore, in order to maximise the visual impact of the clock and reinforce the source of its design inspiration, the movement was engineered around a central axis, mimicking the radial symmetry of a jellyfish's neural column.

Perfecting the glass exterior of Medusa – available in blue, green or pink – was as challenging as any aspect of its movement creation. The pink edition, in particular, required multiple stages of layering red and clear glasses to achieve exactly the right shade desired.



L'ÉPÉE 1839



M B & F

THE DESIGNER

FABRICE GONET

INDEPENDENT DESIGNER FABRICE GONET FIRST PROPOSED MEDUSA IN 2016 TO MB&F FOUNDER MAXIMILIAN BÜSSER. THE VISION WAS SO CLEAR THAT, IN THE END, THE FINAL CLOCK TURNED OUT TO BE VERY CLOSE TO THE INITIAL SKETCH!

REFERENCES

73.6000/134

Green

73.6000/144

Blue

73.6000/164

Pink



MEDUSA  IN DETAILS

A NEW MOVEMENT

L'Épée went back to the drawing board for Medusa, designing the movement entirely from scratch. Due to the weight of the outer glass shell and its vulnerability to shock damage, it was necessary to build a movement that could be wound one-handed, with the other hand available to stabilise the clock. Additionally, with most of the movement surrounded by glass, access to any winding or setting mechanisms would be limited. In a departure from their previous clock movements, L'Épée 1839 combined the winding and setting systems in the Medusa movement. A single propeller element, which projects from the bottom of the movement for easy access, is rotated anticlockwise to wind the movement and clockwise to set the time. Whether in its ceiling-mounted or stand-mounted configuration, Medusa is easily and intuitively wound and set.

With no reinforcing outer support structures, the movement of Medusa has been deliberately built to resemble the internal neural network of a jellyfish, with a central column and radial elements. This feature is not simply aesthetic; in terms of engineering it helps to preserve the integrity of the clock as it is suspended from the ceiling.

DUAL CONFIGURATION

Medusa can be set on a desk or any flat surface thanks to a special steel frame with curved legs, designed to receive the base of the movement whilst allowing for easy access to the winding and setting mechanism. When hung from the ceiling, Medusa can be further decorated with its hand-blown Murano glass tentacles, which hook onto the movement and sway gently with the slightest motion of the clock – recalling a free-floating jellyfish carried along by the current.

A BODY OF GLASS

One of the greatest challenges in bringing Medusa to life was finding a glassblower that could fully realise the design. Like most MB&F + L'Épée creations, Medusa was not designed with the current limits of technique in mind. Instead, technique was developed to accommodate its design. The ethereally light, undulating form of a jellyfish had to be captured in a billowing glass dome that could withstand the entire weight of the 2.34 kg clock.

Maintaining optical consistency between the glass dome and tentacles was essential, so the conventional solution of drawing the tentacles out from pre-formed glass rods was not possible. Instead, the tentacles were produced from the same glass bulk as the dome and individually hand drawn to identical shapes and widths, which requires considerable experience and skill.

Getting the right shade for the pink edition of Medusa proved problematic as well, since the same technique applied for the blue and green editions did not work in this case. Much like vitreous enamel, hand-blown glass is coloured by metal oxides, and the palette is limited by known formulas that have been handed down over centuries of glassworking expertise. The pink glass was therefore achieved by first layering red molten glass over a clear core and then subsequently blowing and drawing the glass out.



TECHNICAL SPECIFICATIONS

LIMITED EDITION
50 pieces per color
FUNCTIONS
Hours and minutes Dual configuration: Ceiling-mounted or Standing
POWER RESERVE
7 days
ENGINE
L'Épée suspended movement, designed and manufactured in-house Balance frequency: 2.5 Hz / 18,000bph 23 Jewels Incabloc shock protection system
WINDING & TIME SETTING
Integrated winding key: unique propeller at the bottom of the movement
DIMENSIONS
231 components Hanging position: 286 mm tall x 250 mm diameter Standing position: 323 mm tall x 250 mm diameter Weight: approximately 6 kg
MATERIALS
Dome/tentacles: Murano hand-blown glass Movement and standing base: stainless steel and brass Indexes and top plate with Super-LumiNova
FINISHINGS
Geneva waves, anglage, polishing, sandblasting, circular and vertical graining, satin finishing.



TECHNICAL SPECIFICATIONS

LIMITED EDITIONS

50 per configuration

FUNCTIONS

Desk clock
Suspension clock : strong cable + hook at the top of balloon
Time displayed with central flame-shaped indicator

WINDING & TIME SETTING

Wound by the basket
Time setting via the button above the basket

MOVEMENT

1855 LR Caliber
Single barrel
17 Jewels
207 components

POWER RESERVE

8 days

MATERIALS

Palladium plated brass and stainless steel

FINISHINGS

Polishing, sand-blasting, satin finishing and painting

DIMENSIONS & WEIGHT

Height 31cm; Diameter 17.2cm;
Height (basket) 8 cm 3.9 kg



HOT BALLOON

TIME TAKES FLIGHT: THE FIRST SUSPENDED CLOCK

Immediate boarding on the Hot Balloon, the mechanical clock in the form of a hot air balloon created by L'Épée 1839. This suspended clock follows the brand's other co-creations – the Vanitas and Arachnophobia wall clocks.

Placed simply on a table or suspended from the ceiling as if flying through the air, this kinetic sculpture symbolizes adventure and whimsy while remaining an exceptional mechanical timepiece.

An official partner of l'École cantonale d'art de Lausanne (ECAL), and specifically its Masters program in Advanced Studies in Design for Luxury and Craftsmanship, L'Épée 1839 created this clock on the theme of travel in collaboration with the talented design student Margo Clavier.

Inspired by the hot air balloon and all that it represents – adventure, imagination, discovery, ambition, freedom – Margo and L'Épée 1839 unveil a mechanical clock with impressive, sometimes floating presence which displays the hours and minutes for eight days.

An authentic piece of watchmaking art, Hot Balloon can also be admired from below, just as one might view a hot-air balloon overhead, as is the very first mechanical clock that can be hung from the ceiling.

The clock is set and wound in either position through an ingenious system that combines form and function, design and engineering, precision and durability. To set the time, simply turn the wheel-shaped crown located in place of the balloon's burner blast valve. Winding the barrel is less intuitive and rather unexpected: the key is the balloon's basket. Simply turn the basket to power the mechanism.

Full of poetry, Hot Balloon comprises 207 components, all produced in-house at the L'Épée 1839 manufacture, and finished and assembled by hand by a passionate team. The clock, sometimes placed on a table, sometimes suspended, measures 31 cm in height, and 17 cm in diameter.

HOT BALLOON WAS BEEN CREATED IN A LIMITED EDITION OF 50 PIECES FOR EACH MODEL :
PALLADIUM, BLACK AND PALLADIUM, BLUE AND PALLADIUM, RED AND PALLADIUM, OR GOLD.



HOT BALLOON

TIME TAKES FLIGHT: THE FIRST SUSPENDED CLOCK

WHIMSICAL, EXQUISITE, CREATIVE

Designed by Margo Clavier, Hot Balloon embodies the dream of travel and adventure. As her first ECAL project, the collaboration with L'Épée 1839 offered a serious challenge: designing a mechanical clock. After visiting the manufacture in Delémont, Margo quickly seized upon the idea of the hot air balloon, which caused a worldwide sensation when it flew for the first time in 1783. Inspired by the aesthetics of the very first hot air balloons, Hot Balloon is an elegant contrast of visible mechanical parts and a metal parts in a variety of finishes and refined decorations.

Every component of the mechanical clock is designed to resemble the parts of a hot air balloon: turning the basket winds the movement; the burners serve as the escapement; the flame indicates the hour and minutes; and finally, the envelope (the balloon), with its wide openings, lends the piece an imposing transparent, airy aspect.

TABLE CLOCK OR SUSPENSION MECHANICAL TIMEPIECE ?

L'Épée 1839 has imagined its tethered flight in a very specific way, offering a completely new way of presenting time. Hot Balloon can be displayed on a desk, a table or a shelf, and it can also be hung directly from the ceiling, floating in air above it all – a first for a mechanical clock of this scale.

Hot Balloon is therefore be supplied with a suspension kit. A very thin cable, fully incorporated into the clock's design, attaches to the hot air balloon, allowing it to take flight. The time is displayed on the balloon's burner; a two-pointed needle resembling a flame indicates the hours and minutes on two black cylinders stacked one on top of the other.

The crown for setting the time is located under the vertical escapement, and its gear train is located between the basket and burner, in place of the blast valve. Just as the flow of gas inflating the hot air balloon is adjusted with the blast valve, the clock's time is adjusted with this crown.

Winding the clock involves the whole basket. Regardless of how Hot Balloon is displayed, to wind the clock, simply turn the base several times (generally six turns), to provide enough power for eight days of flight. For greater ease of use, especially when Hot Balloon is placed on a table, L'Épée 1839 has also made it possible to wind the clock by turning the basket's upper ring, to avoid having to lift the clock.



HOT BALLOON

TIME TAKES FLIGHT: THE FIRST SUSPENDED CLOCK



HOT BALLOON: MECHANICAL POETRY AND WHIMSICAL TECHNOLOGY

To give the design an airy feel, while providing excellent stability, the balloon, which measures seventeen centimeters in diameter, was conceived as a hollow element, so as to allow light to pass through it. Incorporating complex, curved lines into the design was not insignificant for designer Margo Clavier. It is, however, a choice that demanded more from the engineers and machinists, since many hours of turning and machining are required to create this piece.

A block of material had to be turned and machined to hollow out the balloon before creating its pockets and curves. The balloon is formed from one single piece, and a vast one in comparison to typical dimensions of watchmaking.

The basket becomes the mechanical movement, and the mechanical movement becomes the basket. The design of Hot Balloon's movement resembles that of a watch, but on a larger scale. The plate and the bridges of a watch's movement become in this instance the two upper parts of the basket. The second level is therefore the primary, multi-level plate. The barrel and all its gear trains can also be admired from the underside of the basket through the mineral glass.

While a watch's movement is often merely a technical component, sometimes visible but never exposed to the owner's fingerprints, at L'Épée 1839, the movement becomes an object in its own right, designed to be touched, with all the resultant constraints and challenges for the finishes and surface treatments. This perfect combination of form and function is the well-known signature of the brand.

Twenty-five-year-old Margo Clavier has always been attuned to the world of craftsmanship. From a family of artisan chocolate-makers, Margo was raised to value tradition. She naturally turned towards the creative professions. After obtaining her diploma in product design in Roubaix (France), and studying at the National Academy of Art in Sofia (Bulgaria), Margo earned a Bachelors degree at La Cambre, a national university for visual arts in Brussels (Belgium) in 2017.

To further develop her skills in arts and crafts, she decided to enroll in the Masters program in Advanced Studies in Design for Luxury and Craftsmanship at ECAL.

Created almost 10 years ago, this program exposes students to the real world of luxury design, providing opportunities to gain professional experience in table arts, fashion, gastronomy, cosmetics and fine watchmaking.

REFERENCES

74.6002/104
Palladium
74.6002/404
Blue and Palladium
74.6002/204
Black and Palladium
74.6002/504
Red and Palladium



L'ÉPÉE 1839



MARTIN BOLO

TIME MACHINE

IF YOU COULD CHOOSE, WOULD YOU TRAVEL
INTO THE FUTURE OR THE PAST?

L'Épée 1839 has been measuring time for over 179 years, which perhaps explains its passion for reacting to time, even acting on it, or at least constructing it. Inspired by the most famous examples of the genre, L'Épée 1839 unveils its new co-creation, "Time Machine".

In an era when scientific minds continue to ponder the question of whether time travels in one direction only, L'Épée 1839 takes advantage of the present to take off and explore the future.

With a futuristic design inspired by the film world, and a subtle nod to the mechanics of yesteryear, the Time Machine is nothing less than a mechanical sculpture that tells the time. The entire upper part revolves. A single press sets the entire time capsule – the glass tube, the carriage, the time display, and the whole mechanical movement – rotating and transporting you through time.

The two propellers at either end of the carriage are also mobile: the first winds the movement, while the second adjusts the time.

The time capsule, powered by all these rotations, rests on a stable and immobile tripod that ensures total stability for safe take-offs and landings. A wing-nut system at the center of the clock locks the rotation of the capsule and stabilizes the precious mechanism during the journey.

With its 370 components, the Time Machine is a complex table clock measuring 22 cm high and 26 cm wide. It includes a mechanical L'Épée 1839 caliber featuring an 8-day power reserve. As with any dream machine, the onlooker immediately seeks to understand how it works: the motor is therefore visible in its entirety, providing a clear view of the mechanics and their timekeeping.

TECHNICAL SPECIFICATIONS

LIMITED EDITIONS

50 pieces per configuration

FUNCTIONS

Hours and Minutes displayed on two cylinders
Winding and time-setting carried out via the turbine blade on either end of the tube
360° tube rotation

POWER RESERVE

8 days

MOVEMENT

Caliber 1855 – Vertical escapement
17 Jewels
162 components

THE MACHINE

208 components
Fixed tripod
Glass cylinder
Capsule rotation locked by means of a nut system

DIMENSIONS

25.7 x 22 x 21 centimeters
Weight: 5.2 kg

MATERIALS

Brass and stainless steel with palladium,
gold or black PVD plating



Having grown up in a family of cabinetmakers, from his earliest childhood Martin inherited the precious values of two generations of craftsmen. Naturally attracted by manual and creative trades, he embarked on a rather unusual career. After his first qualification in industrial mechanics, he obtained a national diploma in Plastic Arts from the Limoges School of Fine Arts, specializing in object design.

In a bid to perfect his artisanal knowledge and reconnect with his Swiss roots, Martin obtained a place at ÉCAL (the Lausanne canton school of art), to study for a Masters in Advanced Studies Design for Luxury and Craftsmanship.

Collaborations with prestigious companies developed Martin's experience in the professional arena, giving him an understanding of the fascinating worlds of fine watchmaking, culinary arts and haute couture.

A technology and science fiction enthusiast, Martin is naturally attracted to machines, particularly the unlikely kind...

REFERENCES

74.6001/114

Silver

74.6001/204

black and gold

74.6001/214

black and silver



TIME MACHINE



IN DETAILS

IF YOU COULD CHOOSE, WOULD YOU TRAVEL
INTO THE FUTURE OR THE PAST ?

DESIGN: ECHOES OF THE WORLD OF CINEMA

Inspired by the most famous time machines and created with meticulous attention to detail, the Time Machine is the combined result of three minds from very different backgrounds: engineer and creator Nicolas Bringuet, designer Martin Bolo, and artistic director and general manager of L'Épée 1839, Arnaud Nicolas. Together they have created a mobile and truly dynamic scientific instrument that offers some subtle nods to the worlds of industry and cinema, while shining a light on mechanical clockmaking. Each element of the Time Machine has been conceived and designed to evoke a memory. The capsule consists of a glass tube with a propeller at each end, symbolizing movement, the vortex, and science. The technically indispensable part required to lock the tube's rotation is inspired by the very first machine featured in the film «The Time Machine».

Finally, the tripod reflects the temporal convector of one of the most famous American cars of the 1980s, the DeLorean. Every detail is significant.

THE MOVEMENT :

THE KEY ELEMENT OF THE MACHINE

The dynamic thrust of the object is omnipresent throughout this project, since no journey through time can be made without space. L'Épée 1839 thus set out to create a mobile clock. The first striking feature is the 360-degree rotation of the time capsule and the entire gear train of the watchmaking movement visible within it. Every rotating device also needs a locking system: and this one has been designed as a wing-nut that is turned to block the rotation, thus making the owner the key player in its usage.

The Time Machine displays the hour and minutes by means of two black metal cylinders inside a glass cylinder which is framed by a propeller at each end..

The propellers are not simply a significant secondary design element; they are the two key elements of the timekeeping mechanism. The left propeller sets the time, while the right winds the barrel. These two propellers enable the owner to adjust their machine, and thus control their journey through time. Of course, the time capsule containing the caliber 1855, is protected by a cylindrical glass so that no particle can change the future, the past, and the present...making this a true time machine.

We can all picture images of flying contraptions allowing us to travel through time, complete with their bumpy landings. L'Épée 1839 has therefore deliberately created a stationary tripod for stability on all surfaces, whether a runway or a simple desk, while incorporating slight flexibility in the foot (the only element in contact with the ground during an eventful landing!).

THE TIME MACHINE IS PRODUCED IN THREE LIMITED EDITIONS OF
50 PIECES EACH : SILVERED, BLACK AND SILVERED, AND BLACK AND GOLD.





TECHNICAL SPECIFICATIONS

LIMITED EDITIONS

50 items per colour

FUNCTIONS

Regulator: independent, white bright black pad-printed dials placed one on top of the other with hour indicator on the upper dial and minutes on the lower dial.

MOVEMENT

1853RV calibre – horizontal escapement

JEWELS

11

POWER RESERVE

7 days

WINDING

Wind the movement with solitary valve on right side

TIME SETTING

Set the time with crown on top of the derrick

MATERIALS

Stainless steel and brass with gold or palladium coating

FINISHINGS

Hand polishes, satin-finishings and sand-blastings

CASE

Black aluminium and mineral glass

DIMENSIONS AND WEIGHT

178 x 10 x 23.3 cm – 3.2kg



L'ÉPÉE 1839



MARTIN BOLO

GAZ DERRICK

EXTRACTING HOURS AND MINUTES

Countless trips through space with the Starfleet Machine and Destination Moon, or through the depths of the ocean with Octopod; closer to the surface, L'Épée 1839 seizes control of Planet Earth with the launch of its new kinetic timepiece: Gaz Derrick. Hours and minutes rise up from the movement and involve a new caliber that has been recently developed by the manufacturer.

Whether drilling on an offshore platform or inland, Gaz Derrick boasts of 2 dials in the shape and style of gas gauges; each displays the hour and minutes.

The winding and time-setting key is embedded on the dock. The time setting nod is the gaz burner located on top of the derrick symbolizing the possibility to overcome any unexpected problems. As no holes can be made close to a gaz field, a control-valve-shape winding key is located on the right side of the base allowing the owner to operate the release of energy. Designed, developed and manufactured by L'Épée 1839 in the Jura (Switzerland), Gaz Derrick takes its inspiration from vast industrial landscapes that captured our imagination and turns that into a tangible, luxurious and meticulous interpretation.

Reading the time as reading gage: Hours and minutes are displayed on two distinct and independent dials – somehow like a regulator – placed on top of each other, in the middle of the derrick. The similarities between the dials and true industrial gages are such that they drive us to the command-centre of the gaz derrick. All around, there are several elements, evoking a detailed realism, that pique your curiosity: valves, pipelines, reservoirs, pumps, and even a central drilling axis. The scenery of a complete exploitation.

Similar to conventional structures, the clock mechanism is powered by the earth's energy. The power source is located in the black base that supports the various decorative elements. A careful eye will easily find the gears, escapement and the unique barrel that keeps energy. The movement allows for precise timekeeping for up to 7 days. Made up of 281 fine pieces and expertly assembled by hand, the handwork can be admired through discreet openings at the base of the derrick.

This normally overwhelming industrial landscape is now presented in a more restricted size: 23 centimetres high with a width of 178 centimetres and 10 centimetres in depth.

GAZ DERRICK IS PRESENTED IN TWO LIMITED EDITIONS (50 PIECES EACH) WITH A BLACK BASE ; THE MOVEMENT AND ELEMENTS ARE EITHER YELLOW GOLD- OR PALLADIUM-PLATED.



GAZ DERRICK

EXTRACTING HOURS AND MINUTES

A SPECTACULAR ARTWORK WHEN IT COMES TO WATCH-MAKING

Inspired by various types of building toys from their childhood, young talented designer Martin BOLO and Arnaud Nicolas, Brand Director, succeeded in creating a homogeneous and realistic structure, relying on the high-quality workmanship courtesy of L'Épée 1839's age-old expertise.

The main elements of a gas extraction platform become an example of industrial architecture, the design allowing you to quickly and easily identify the structure behind this clock. In the middle, the derrick is standing, then the pipelines, valves and pumps. Everything is protected by a harmonious and fine squared protective glass atop the black base. The design forces you to be closer to the elements; it's true to life, but is still a thing of beauty, leaving you with the aestheticism of its lines and everything else to your imagination... The excellent workmanship typical of L'Épée 1839 is of course present.

THE INDUSTRY AT A GLANCE

The most impressive element of this kinetic sculpture is without any doubts the derrick. It measures more than 14.3 centimetres – this is a far cry from standard watch-making dimensions – and both the gold and palladium versions boast of perfect finishes. Essential for drilling, it is the key element here as well. The derrick supports the axis which sends power and information from the clock mechanism to the hour and minute hands.

Inside the derrick, the perfectly executed drill strings are used to hoist rock fragments and gas. Gaz Derrick also incorporates this drill string; it has been turned into the central axis for the timer, which allows you to set the hour and minute indicators. Lower down, on the ground level, you will find a few typical

elements that bring to mind a particular world while at the same time remaining true to the design. The inquisitive spirits and questioning minds who wish to have a deeper understanding of the realisation will wonder where the winding-key hole is. In fact, there is none... Remember we are in a special environment; no holes can be made. So, the control valve, on the right side of the base field, is in fact the key for winding the movement.

Each week, all you have to do is to open the valve so that enough power is supplied to the clock, just as a petroleum operation manager will feed the gas derrick with gas. By making between 5 and 7 complete rotations, the watch will be run for the next 7 days.



GAZ DERRICK

EXTRACTING HOURS AND MINUTES

A FIRST-TIME TECHNIQUE FOR THIS L'ÉPÉE 1839 MOVEMENT: THE REGULATOR

After having developed a movement with arms for Sherman, or legs (Arachnophobia) or even accompanying it with a skull mechanism (Requiem), L'Épée is bringing one of its signature calibre movements back to the table and offsets the hour and minute indicators thanks to bevel gears – a new technical challenge! Discover a horizontal movement with horizontal escapement paired with a central axis of nearly 200 mm in length; this enables L'Épée 1839 to display hours and minutes way off its original position. Displayed separately, like the regulator movement of a watch, two independent dials allow you to read the hour and the minutes away from the movement itself. Somehow like the operator reading the instrument in the safety zone...



Here, the key drilling axis element of a derrick becomes the central axis for the hour and minute hands, displaying all information to the user as though it were a derrick. Going even further with this industrial aspect, the dials themselves have been designed to look like manometers.

A derrick gas burner, located on the top, allows you to adjust overpressure and maintain safe installation; at L'Épée 1839, the Burner becomes the time-set crown, allowing you to adjust the hour in case the power supply runs out; for example, if the owner forgets to wind the mechanism. With its one-week power reserve, the 1853RV calibre mechanical movement is entirely made at the Delémont factory workshop.

Just as rich mineral resources are extracted from beneath the ground to fuel the need for power, the Gaz Derrick by L'Épée 1839 runs on the energy of its barrel located inside the base, underneath the derrick. Regulators used in the petroleum industry are based on a system of pressure relief valves; here, the same happens but in the form of a time regulator with its actuator gear train and escapement. A signature feature for the brand, the mechanism is visible through potholes, enabling those who like beauty and mechanical structures to appreciate the workmanship. Day or night, drilling platforms must keep running and need to be able to provide information on their status... So, Gaz Derrick features two hands equipped with Superluminova so that you can read the time regardless of the lighting.

L'EPÉE 1839



M B & F



BALTHAZAR

THE DUALITY OF
MAN AND MACHINE

Balthazar is a sophisticated and imposing high-precision robot clock displaying jumping hours, retrograde seconds and a 35-day power reserve. Weighing in at over eight kilograms (18 pounds) and standing nearly 40 centimetres tall (16 inches), Balthazar is composed of 618 beautifully finished, micro-engineered components.

But beware... there is also a dark side to Balthazar, as there is in all of us.

Rotate his torso 180 degrees and discover a terrifying Balthazar, along with a dual hemisphere moon phase indicator that should help you anticipate the evolutions of your mood. To quote Darth Vader in Star Wars, «If you only knew the power of the dark side.»

Light side : boasting a month-busting 35 days of power reserve, Balthazar's clockwork displays «slow» jumping hours and trailing minutes via two discs on the chest, while the power reserve indicator is located on his belly. This side of Balthazar may be serene, but he is still always on guard : his red eyes, which continually scan the surroundings, are actually 20-second retrograde displays.

Moving higher still to Balthazar's «brain» under the polished glass dome, we find the precision regulator of the clockwork. The animated balance constantly oscillates to let you know that while he may be standing still, Balthazar is always calculating. Balthazar rotates around the hips like the high-precision machine that he is; you can feel the minuscule bumps of each micro-roller as he turns, and each distinct notch when he rotates the full 180°. Then everything changes : smiling Balthazar becomes very dark, or vice versa.

Dark side : The absolute nature of Balthazar's darkness is revealed by the cold hard skull with menacing teeth and deep-set ruby-red eyes. But it's not all threat here as Balthazar's chest also contains a moon phase display accurate for 122 years. You can adjust the moon phase manually, providing one of many of Balthazar's tactile pleasures.

Balthazar does more than display horological events : as well as rotating around the hips, his arms articulate at both the shoulders and the elbows, and his hands can clasp and hold objects.

Finally, Balthazar's shield conceals and protects the secret of his awesome power : an integrated clock-winding and time-setting key.



LIMITED
EDITION OF
20
PIECES
PER
CONFIGURATION

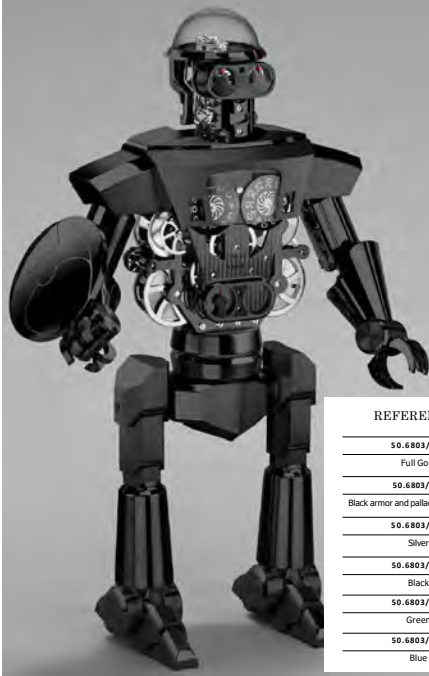

REFERENCES

50.6803/001
Full Gold
50.6803/211
Black armor and palladium movement
50.6803/104
Silver
50.6803/201
Black
50.6803/301
Green
50.6803/401
Blue

BALTHAZAR



IN DETAILS

BALTHAZAR – A ROBOT-CUM-TABLE CLOCK

Balthazar doesn't just look like an incredibly solid piece of complex high-precision micro-engineering, he is just that: an incredible 618 components go into the construction of his body and clockwork, which are more pieces than in most complicated wristwatches.

Surprisingly, because of Balthazar's size and he is even heavier than he looks – manipulating any of Balthazar's joints and even the moon phase indication is extremely tactile. Moving anything on this robot is like gently closing the door on a high-end German sedan; it's the type of feel that requires much more than excellent high-precision micro-engineering capability, it requires caring deeply about touch, sensations, and even sounds from the outset. Balthazar is built to watchmaking precision by a team that cares deeply, you can feel it.

BALTHAZAR IS FULL OF SURPRISES

joints move in ways that astonish; motions feel so wonderfully better than you expect that you want repeat them again and again. The build quality continually surprises and it's hard to emphasise just how solid Balthazar feels. Then there is yet another surprise: the double-depth square-socket winding/time-setting key integrated neatly into the shield, which naturally slips in and out of its concealed niche with horological precision.

And for those who look very carefully into those eerie, ruby-red, Terminator-style eyes set deep into Balthazar's skull, there is an ultimate surprise perfectly illustrating just how seriously the team takes the notion of form-follows-function.

Those red eyes are actually the ruby bearings that support the 20-second retrograde eye displays on the other side of his face.

So L'Épée 1839 developed a 'slow' jumping hour, which sees the hour disc remain static for 55 minutes and then – rather than jump instantly and risk the jump being missed – start to turn five minutes before the hour. The jump is so gradual that it can be easily seen.

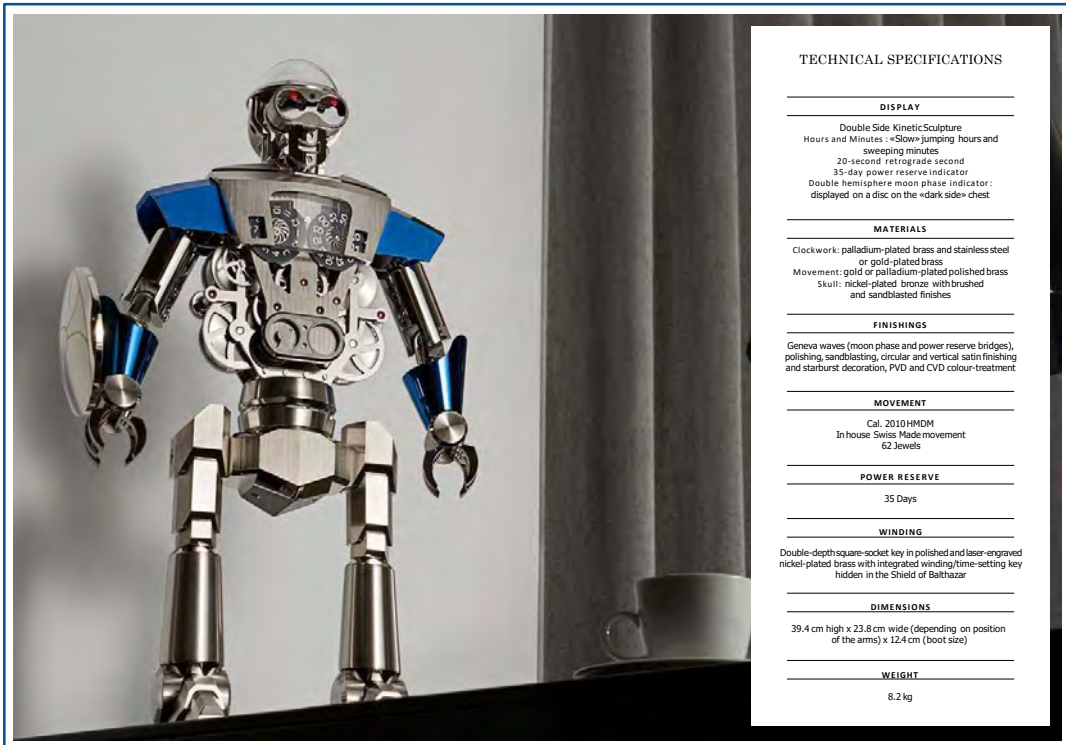

TECHNICAL SPECIFICATIONS

DISPLAY

Double Side Kinetic Sculpture
Hours and Minutes : «Slow» jumping hours and sweeping minutes
20-second retrograde second
35-day power reserve indicator
Double hemisphere moon phase indicator : displayed on a disc on the «dark side» chest

MATERIALS

Clockwork: palladium-plated brass and stainless steel or gold-plated brass
Movement: gold or palladium-plated polished brass
Skull: nickel-plated bronze with brushed and sandblasted finishes

FINISHINGS

Geneva waves (moon phase and power reserve bridges), polishing, sandblasting, circular and vertical satin finishing and starburst decoration, PVD and CVD colour-treatment

MOVEMENT

Cal. 2010 HMDM
In house Swiss Made movement
62 Jewels

POWER RESERVE

35 Days

WINDING

Double-depth square-socket key in polished and laser-engraved nickel-plated brass with integrated winding/time-setting key hidden in the Shield of Balthazar

DIMENSIONS

39.4 cm high x 23.8 cm wide (depending on position of the arms) x 12.4 cm (boot size)

WEIGHT

8.2 kg



VANITAS

L'EPÉE 1839 BY FIONA KRÜGER

Fiona's Fine Art and Design training, combined with her international upbringing are apparent in the design of this mechanical symbol. Having spent part of her childhood in Mexico City her vivid memories of the Dia de los Muertos festival have influenced her own skull collection and this latest collaboration with L'Épée.

This mechanical Vanitas is rich in symbolism but also in humour. The bridges of the clock are intricately detailed, designed to build up into a pattern which ultimately forms this ornate skull. Creativity is at the heart of both L'Épée 1839 and Fiona Krüger Timepieces.

This looks evident in this modern day Vanitas kinetic piece of Art with its humorous twist. The new "yawning" power reserve indicator required a whole new development and re-engineering of the clock movement. It is a marriage between fantasy and purpose which is at the core of the collaboration.

CREATIVE ART  L'EPÉE 1839

Ref. 50.6001/300

Closed mouth: Empty power reserve



Ref. 50.6001/200

Opened mouth: Empty power reserve



L'EPÉE 1839



FIONA KRÜGER

VANITAS

L'EPÉE 1839 BY FIONA KRÜGER

VANITAS: A WALL CLOCK AS NO-ONE AS SEEN BEFORE!

When picturing a clock in your mind, everyone has a similar idea – round, 12 hours, two hands. Vanitas defies convention – the clock is itself a Skull, with mechanical eyes, a moving mouth and a distinctive case shape which frames the skull-shaped movement inside. The multi-layered bridges each have a specifically chosen finishing and décor, bringing depth to this sculptural skull. The hands bring a sense of familiarity to this innovative design which defies convention and brings together the worlds of Fine Art and HauteHorlogerie.

AN OUT-OF-THIS-WORLD DISPLAY

Next to all known contemporary Wall clocks, Vanitas stands out like a bold brush stroke on a blank canvas. This new co-creation features a frontal escapement, 2 barrel arbors as "pupils", all designed to sculpt the mechanical skull's face. Vanitas indicates the time by way of two hands which are centrally mounted on the nose. These hand-polished hands indicate the hours and minutes, hiding and revealing the skull's eyes as if it was playing hide-and-seek. Power reserve indicator: an indicator framed by two rows of teeth opens up as time passes, providing an intuitive view of remaining energy. When the mouth is completely opened (18.5mm a part from each other) the clock looks like it is "yawning" as a warning to its owner that it will go to sleep if some energy is not provided.

WALL CLOCKS – JUST LIKE BIG WATCHES ?

Vanitas is a luxury one-of-a-kind wall clock, featuring essentially the same mechanisms as a wristwatch, only larger : gear train, mainspring barrels (well, five in series), balance wheel, escape wheel and anchor. L'Épée's regulator also features an Incabloc shock protection system, something generally only seen in wristwatches, which minimises the risk of damage when the clock is being transported.



TECHNICAL SPECIFICATIONS

LIMITED EDITION

50 pieces per configuration and available in 'dark' and in a colourful edition

DISPLAY

Hours and minutes
Power reserve indicator

MATERIALS

Aluminium Skull, stainless-steel and brass movement

FINISHINGS

Dark' version:

Mat Housing in Black Anodized Aluminum with mineral glass. Mechanism in palladium-coated brass.
Movement Main plates in black PVD coated brass.
Multi-layered screenprinted white decoration (gloss ink)

Colored Version:

Mat Housing in Black Anodized Aluminum with mineral glass. Mechanism in palladium-coated brass.
Movement Main plate in brass black PVD coating.
Multi-coloured screen-printed pattern (gloss ink).
Meanings of colours: Blue = Trust, White = Purity, Orange = Sun, Yellow = Death, Pink = Celebration, Red = Life and Purple = Grief and Black = Mortality

MOVEMENT

Five barrels inserie
12 Jewels

POWER RESERVE

35 days
Closedmouth: Full power reserve
Openedmouth: Empty power reserve

WINDING

Manual-winding on the skull face: Double-ended key to set time and wind movement

DIMENSIONS

Height: 306 mm - Width: 220 mm - Thickness : 86 mm



VANITAS

L'EPÉE 1839 BY FIONA KRÜGER

The Skull is the ultimate symbol of life, death and human experience – as such it has played a key role in both Horological History and Art History. Through Fiona Krüger's artistic approach to Haute Horlogerie and L'Épée's know-how, the Skull has been re-interpreted into a mechanical Vanitas painting for the 21st Century.

Vanitas is engineered and crafted by L'Épée 1839, Switzerland's specialised high-end clock manufacturer, founded in 1839. This charismatic cranium reminds you to celebrate life. The hours and minutes are shown by the clock's hands, and a power reserve indicator is integrated into the mouth of the skull. As Vanitas loses power it starts to yawn, indicating it needs to be wound up. Though with a 35-day power-reserve, this monthly ritual will give you a moment to stop and take stock of the time you have.

LIMITED EDITION OF
50 PIECES PER CONFIGURATIONS :
DARK AND COLOURFUL



REQUIEM

CELEBRATE LIFE WITH A KINETIC SCULPTURE
THAT TELLS THE TIME

Requiem: a table clock with an 8-day movement designed in partnership with Kostas Metaxas. This limited edition takes its inspiration from the shape of a human skull and displays the time in the sockets of the eye.

Opting for a timeless artistic genre: Memento Mori, L'Épée 1839 and the designer take on a graphic and technical challenge. Memento Mori, literally translated as «Remember that you are going to die», reminds Man of the humility he must show in the face of eternity.

Requiem is a table clock designed and manufactured by L'Épée 1839, Swiss specialist of high-end kinetic clocks. It measures nearly 19 centimeters (7.4 inches) high and weighs about 2 kilograms (6 pounds). It is made of cast aluminum which is then perfectly finished off in the Swiss workshops of L'Épée 1839. Three skull finishings are available: a black skull associated with a movement in gold-plated brass, or a silver color version: aluminum skull and palladium-plated movement, and a rainbow skull that has his own color in between violet, green with many more reflections of light. The new movement is an internally designed 1853 HMD caliber with an 8-day power reserve. This new movement features two discs that display a «slow» jumping hour and sweeping minutes.

Kostas Metaxas has chosen to place a horological mechanism deep in the center of the skull, representative of a brain which is master of its destiny but encapsulated. Symbols of intimate ties uniting life and time. The eyes, on the other hand, are spectators of time passing and quite naturally the hour invites itself in the eye sockets. The reading of the hours and minutes is achieved by two transparent discs placed respectively in the right eye and the left eye. So you must face your fears and look at Requiem in the eyes ... to know... the time.

REFERENCES

76.6003/300
Rainbow
76.6003/200
Black & Gold
76.6003/100
Aluminium
76.6003/210
Black & Palladium

REQUIEM IN DETAILS



THE MOVEMENT

Composed of 160 pieces entirely designed, finished and assembled in the workshops of L'Épée 1839 (except the 24 rubies), the movement is available in two finishings: gold or palladium. The hour and minutes are displayed inside the eyes, thanks to a system of discs on which the time indications are stamped. L'Épée 1839 adds a whole new complication to its 8-day movement: the disc mechanism displays a «slow» jumping hour and sweeping minutes respectively. In the presence of a conventional jumping hour indication, it is difficult to know whether the jump has already taken place or not. It is therefore possible to misread the time. In order to avoid this, L'Épée 1839 developed a «slow» jumping hour. As a result of this complication, the hour disk remains stationary during the first 55 minutes of an hour; Then, rather than jumping instantly, it starts to slowly turn five minutes before the new hour. This gradual jump is more easily noticed and the reading of the time is made easier.

With an 8-day power reserve, Requiem has to be rewound each week, so offering an intimate moment with its symbolic, thanks to a key specifically placed at the base of the skull, as to represent an essential axis in the human being. From the nape of the neck or more precisely from the cervical plexus in Humans, all information, wills and decisions will be sent to the organs and members. Here, it is the energy necessary for the proper functioning of the table clock which is transmitted through this gesture. The unique key also allows you to set the time.

THE SKULL

Far from the traditional clock, these 2 kilograms of skull can disturb even in all of its sobriety. Two swords were engraved on the sides of the aluminum skull to let in the light and give reflections to the movement. The jaw designed to be very realistic is composed of 24 independent teeth.

Each story, each life, each skeleton is unique, bearing the stigmata of time. To make the timepiece even more realistic, L'Épée 1839 has deliberately left small defects, specifically, individually and harmoniously located on each skull, as a sign of life, leaving you to imagine a story and making each timepiece totally unique.

The skull rests on two pillars, recalling the two trapezius muscles, in the middle of which the key is positioned. The aluminum base ensures the stability of the clock.

REQUIEM IS A LIMITED EDITION OF 39 PIECES PER CONFIGURATION: BLACK SKULL AND GOLDEN MOVEMENT, OR ALUMINUM SKULL AND PALLADIUM MOVEMENT (SILVER COLOR), AND A RAINBOW SKULL WITH GOLD-PLATED MOVEMENT AND TEETH.

TECHNICAL SPECIFICATIONS

LIMITED EDITION

50 pieces each in configurations: Black, Aluminium, and Rainbow

DISPLAY

The slow-jumping-hour and minutes are displayed in the eyes of the skull with two stamped discs.

MATERIALS

Aluminium Skull, stainless-steel and brass movement

FINISHINGS

Polishing, bead-blasting, satin finishing and lacquer

MOVEMENT

1853 HMD caliber
Single barrel
24 Jewels

POWER RESERVE

8 days from single barrel

WINDING

Manual winding by a specially designed unique key

DIMENSIONS

19cm high x 12cm wide x 16cm deep

WEIGHT

Approx. 2kgs



LE DESIGNER

KOSTAS METAXAS

" THE CLOCK IS A FASCINATING OBJECT BECAUSE YOU CAN PLAY WITH WHAT YOU HIDE AND WHAT YOU UNVEIL "

Kostas Metaxas is a magazine editor, film producer, art and technology enthusiast. He feeds on different sources, and his various and different activities complement each other to enrich his creative work. His artistic journey is unconventional: from art to design, but for him, it was the obvious step. It is with a wise and multicultural artist's eye that he approaches this new conception. His creations are unique and he has been awarded many times for his talents as a designer.

Australian of Greek parents, Kostas Metaxas travels the world from Darwin to London, from the Greek islands to Germany. It was during his travels that he found the inspiration of Requiem, resulting from his limitless imagination and his love for music. Self-taught, he likes to understand and discover new materials when he conceptualizes objects. In collaboration with L'Épée 1839 research and development team, he applies contemporary technologies, and exploits metals to innovate and create.

When asked why so much sobriety in the exterior design, he replies: "This is part of the fascination that I feel with respect to watch complications."

Thus the ideas of limited terrestrial time and complex mechanical watchmaking envelope can be seen as a metaphor or allegory of life itself (and of all its complications...).

Kostas Metaxas simply succeeded, by drawing this skull, to summarize the famous equation of life. Although not everything is equation, Google will certainly have any kind of answer to offer on this subject, but on principle we all agree that the equation of life is a fragile balance between time and happiness lived from birth to death. Hence, the symbolic human skull, illustrating the passing of time, takes on its full meaning, especially when light comes to rest on the movement through the few openings, and so reflects, for a moment, touches of gold and silver within a gloomy universe.



SHERMAN

THE LITTLE ROBOT WITH A BIG
SUPERPOWER

L'EPÉE 1839



MB&F

Sherman's mechanics are based on a L'Épée 1839 in-line eight-day movement, which ensures that the friendly tank-treaded table clock can display the correct time on his chest for more than a week before requiring rewinding.

But Sherman is not simply a clock inside a robot, but an integral and holistic robot-clock. The mainspring barrel bridge extends down to support his tracks, movement spacers act as shoulders for the arms, and his eyes are bolt heads supporting the regulator. The movement plates and bridges of the clock also make up the skeleton and body of the robot.

The transparent blown mineral glass dome on Sherman's head reveals his mechanical brain, which is actually the regulator controlling the precision of the robot's time. It's mesmerising to watch the little guy «think».

SHERMAN'S SUPERPOWER

Sherman may be small for a robot, but he has an incredibly powerful superpower : the ability to spread happiness and to make people smile. Sherman's superpower is so dominant because smiling is contagious (one person with a grin sets off a fast-spreading chain reaction) ; reduces stress and anxiety ; releases endorphins, dopamine, and serotonin (our body's natural mood-enhancing chemicals) ; strengthens the immune system (by increasing the number of white blood cells) ; makes us more approachable; lowers the heart rate and relaxes the body; makes us look younger ; increases longevity ; and makes us more attractive to others.





SHERMAN



IN DETAILS

SHERMAN'S TIMEKEEPING

Working from designs supplied by MB&F, L'Épée developed Sherman's body using its eight-day, in-line movement as a structural base.

Located under the transparent dome of Sherman's head, the movement's regulator – consisting of the balance and escapement – features an Incabloc shock protection system to minimise the risk of damage when the robot is moving or being transported. While shock protection is standard in wristwatch movements, it is more unusual in generally immobile clocks. But then Sherman is no normal clock; he is a robot with a mission: to make the world a happier place.

SHERMAN'S NAME

Sherman's name – as his continuous tracked undercarriage hints at – is derived from the prolific M4 Sherman tank used by the USA and its allies in World War II. Despite being technically surpassed by larger and more powerful tanks toward the end of the war, the Sherman tank proved to remain effective because it was extremely reliable and easy to produce. Better to have lots of smaller tanks in action than smaller numbers of larger, more complex tanks sitting in the garage.

Officially called the Medium Tank M4; it was dubbed the Sherman M4 by the British, who named it after General William Tecumseh Sherman.

Sherman rose to command the Western Union army (succeeding General Ulysses S. Grant) during the American Civil War (1861 - 1865) and then headed the American army when Grant assumed the presidency.

British military historian B. H. Liddell Hart called Sherman « the first modern general ».

While the name of Sherman may have originated in a war scenario, he is most definitely a robot of peace. Sherman is fitted with the most powerful weapon of all : the ability to spread happiness and unabashed joy.



TECHNICAL SPECIFICATIONS

LIMITED EDITION

200 pcs each for reference 76.6001/041 and 76.6001/101
50 pcs each for reference 76.6001/051 and 76.6001/151

FUNCTIONS

Hours and minutes displayed on Sherman's chest

MOVEMENT

Cal. 1853SK2

POWER RESERVE

8-day

Double depth design key to set time and wind movement (on the back of the clock)

FINISHINGS

Geneva waves, Mirror polish surfaces and sun satined finishings

JEWELS

17

DIMENSIONS

143 mm tall x 109 mm wide x 80 mm deep

MATERIALS

76.6001/041 : Gold-plated with palladium-plated going train (gearing) and nickel-plated balance wheel
76.6001/101 : Palladium-plated (silver colour)
76.6001/051 & 76.6001/151 : Fully gold-plated body and movement (ref. 051), or palladium-plated (ref. 151), with gem-set with 735 high quality VVS diamonds around the eyes, hour markers and head



L'EPÉE 1839



MB & F



ARACHNOPHOBIA

TELLING THE TIME WITH TWO HANDS
AND EIGHT LEGS

In the last years, The L'Épée Manufacture, in partnership with MB&F – the Geneva Based creative lab, has presented some very extreme machines, and the visually powerful Arachnophobia is as extreme as they come.

Despite Arachnophobia's intense appearance, the eye-catching three-dimensional sculpture is also an impeccably finished table (and wall) dock.

Engineered and crafted by L'Épée 1839, conceived and developed by MB&F, Arachnophobia is the result of Maximilian Busser's overactive imagination blending with appreciation of art.

Arachnophobia was inspired by a giant spider sculpture called Maman that Büsser had seen in both Geneva and Doha. Maman (mother in French), was created by Louise Bourgeois (1911 - 2010) in bronze, stainless steel, and marble. Measuring 9.27 x 8.91 x 10.24 metres (more than 30 x 33 feet), the monumental sculpture has been installed in a variety of locations around the world.

The Highly unusual concept was developed, selecting a high end L'Épée clock movement and re-imagining it as the mechanical head and torso of a spider. The body is outfitted with a black dome with white numerals depicting the hours and minutes. The araneae's self-sufficiency is to be admired, for the finely-finished, highly-visible movement boasts a power reserve of eight days.

At either end of Arachnophobia's time-displaying abdomen, important mechanical processes take place: the head houses the regulator with its oscillating balance wheel (and a set of jaws in case it gets peckish at night), while the other end contains the mainspring barrel, which powers the movement. Attached to the abdomen are eight, visually enticing legs articulated where they join the body by ball-and-socket joints. The legs can be rotated so that Arachnophobia can stand tall on a desk or splayed flat for wall mounting. A third position provides an optical treat for fans of large arachnids: the front legs can be moved forward while the six others maintain the standing position, an interesting and alarming posture that says, look out!



REFERENCES

76.6000/011

Gold-plated brass

76.6000/114

Palladium-plated brass and Black lacquer coated aluminium



ARACHNOPHOBIA – ASPIDER-CUM-TABLE-CLOCK-CUM-WALL-CLOCK

Arachnophobia comprises no fewer than 218 components, each one (except the jewels) machined and finished at L'Épée's Swiss atelier.

Manufacturing realistic legs to faithfully replicate MB& F's unusual design was no easy task. L'Épée had to find a solution for the legs that ensured that they would be both realistic-looking and articulated. The legs also had to conform to the standards of high watchmaking in that they could be nicely finished by hand. L'Épée came up with the novel solution of injection moulding metal to obtain the precise geometry needed. Injection moulding is a process of manufacturing components by injecting material (in this case metal) into a mould. The material is first subjected to high heat, then forced into the mould cavity. It then cools to the desired shape before being removed from the mould. While this is a very common process for shaping plastics, it is less common for shaping metals.

Arachnophobia is available in two colours, yellow gold and black, which required two different metals for the legs. The gold-coloured edition features gilded brass legs, while the black version's legs are made of injection-moulded aluminium, which is hand-finished and lacquered black.

"When the legs come out of the injection mould, they are really rough and need a lot of attention to be as nicely finished as they are in the end" says L'Épée CEO Arnaud Nicolas.

"All of the finishing is accomplished by the hands of master finishers, who grind, satin-finish, polish, and then plate or lacquer the legs depending on the version."

Finishing techniques used on the clock's "body" and legs include anglage, mirror polishing, satin finishing, circular satin finishing, sand-blasting, and polishing. "The most important thing was to play with light on each one of the spider's parts," Arnaud Nicolas continues. *"Some of the parts were sandblasted to continue the light play."*

The eight legs are connected to the clock «body» by ball-and-socket joints. By rotating them the legs can be made to go flat; turning them around again allows them to stand up high like the *Bourgeois* sculpture that inspired them. The front legs can also be pushed forward while the six others maintain the standing position. *"This makes the spider look like it will bite something"* Arnaud Nicolas laughs.



Arachnophobia is available in two colours: **black or yellow gold**. While individual tastes will vary, the black version is more realistic-looking and may be even intimidating to some; the gilded model has a more sculptured artistic appearance.

While Arachnophobia is not nearly as large as the sculpture that inspired it, at 405 mm in diameter with the legs fully extended, or hanging on a wall, it is certainly large enough to make a real impression. Whether that impression is positive or negative depends on how much you enjoy creepy-crawlies.

ARACHNOPHOBIA IS AVAILABLE IN BLACK OR 18K YELLOW GOLD-PLATED EDITIONS



ARACHNOPHOBIA: TABLE CLOCK OR WALL CLOCK

The clock is delivered with a special wallkit to adapt Arachnophobia, from a Table Clock to a Wall Clock. The legs can be moved into various positions, on a table or on a wall, for example: Flat – Upright – Attack.

ARACHNOPHOBIA'S MOVEMENT IN FOCUS

In creating Arachnophobia's highly visible movement, L'Épée had to transform its eight-day movement to look more like a spider body. The palladium-plated main plates were redesigned as was the layout of the gear train to fit the design. The escapement was rotated 90° to better represent the head.

The hours and minutes are read on a high dome representing the spider's body, with rotating curved hands indicating hours and minutes on a polished, central dome featuring MB&F's signature numerals.

The movement's regulating organ features an Incabloc shock protection system, which minimises the risk of damage when the clock is being transported. This type of shock protection is generally only seen in wristwatches. The index mechanism for fine-tuning the timing, along with other components of this all-important high-precision subassembly, are clearly visible on the head.

The movement features superlative fine finishing of the type generally found on the finest wristwatches, including Côtes de Genève, anglage, polishing, sand-blasting, and circular and vertical satin finishing. However, finely finishing a clock movement is far more challenging than finishing a wristwatch because of the greater surface areas of the larger components.

L'Épée CEO Arnaud Nicolas explains: "It's not simply a case of double the size of the components, double the time it takes to finish them. The complexity increases exponentially. For polishing, for example, you need to apply the same pressure as when finishing a watch movement but on a bigger surface – and any variation in that pressure is visible."

WINDING AND SETTING ARACHNOPHOBIA

The underside of the spider is the key (quite literally) to winding and setting Arachnophobia. The owner must interact with the clock in an intimate manner to wind and set the time of this precision instrument, thereby building a close relationship with it.

TECHNICAL SPECIFICATIONS

POWER RESERVE

8 days

MATERIAL

76.6000/011 : Gold-plated brass
76.6000/114 : Palladium-plated brass

MOVEMENT FINISHING

Includes Côtes de Genève, anglage, polishing, sand-blasting, circular and vertical satinfinishing

JEWELS

11

DIMENSIONS

203 mm in height (legsextended);
Clock diameter (legs flat) 405 mm;
Movement dimensions: 75.3 x 134.9 x 63.8 mm

WEIGHT

Gold-plated version 1.96kg
Black version 0.98 kg

WINDING

Winding and time setting on underside of the clock, on the spider belly, with a unique design key

26



TECHNICAL SPECIFICATIONS

DISPLAY

Hours and minutes
Curved, handpainted hands rotate on a black central dome
Double retrograde seconds
20 second intervals indicated by double retrograde flyback cannons
Power reserve indicator :40 days represented by a dome indicator framed by handfinished arcs. Intuitive view of remaining energy, turns 300°. Complemented by a «radar dish» that also revolves 300°

MAIN STRUCTURE

Height: 21 cm
Diameter: 29 cm

MATERIAL

Stainless steel and palladium plated brass

MOVEMENT

L'Épée inhouse designed and manufactured movement
Balance frequency: 18,000 bph / 2.5Hz
Barrels :5 in series

JEWELS

48
Incabloc shock protection system

WINDING

Manual winding: double ended
key to set time and wind movement



STARFLEET
machine

IT'S A TABLE CLOCK, JIM, BUT NOT AS WE KNOW IT!

50.680/301

Palladium-plated movement with Chocolate-bronze-color (PVD) brass

L'ÉPÉE 1839



BLACK BADGER

It's nothing new to see one of L'Épée 1839's high-end, Swiss-made timepieces flying over the Atlantic at twice the speed of sound: L'Épée's beautifully-crafted wall clocks were chosen to furnish Concorde cabins when the supersonic aircraft entered commercial service in 1976.

Unfortunately Concorde is no more. However, thanks to the aero-horological design team at MB&F, there is now another supersonically-themed L'Épée clock, which will not only traverse the stratosphere, but explore deep space and beyond: Starfleet Machine!

Starfleet Machine is engineered and crafted by L'Épée 1839, Switzerland's only remaining specialised high-end clock manufacture, founded in 1839. Starfleet Machine is an intergalactic spaceship-cum-table clock, featuring hours and minutes, double retrograde seconds and power reserve indicator. The highly visible, superlatively finished in-house movement boasts an exceptional power reserve of 40 days (you need a large fuel tank for long space voyages).

Starfleet Machine has been designed by MB&F, the award-winning artistic and micro-engineering laboratory. Hours and minutes are indicated on the central black dome by hand-polished hands that follow the dome's curved contours. Behind that, a smaller rotating dome, accompanied by a revolving radar dish, provides an intuitive view of remaining energy: five bars indicates the movement is fully wound (40 days of power); one bar means Starfleet Machine is running low on propellant (eight days of remaining power) – it's all relative – most table clocks have a maximum power reserve of only eight days.

Below 12 o'clock on the central hour-minute dome are the double retrograde seconds in the form of turret-mounted laser cannons. The cannons start in parallel and cross over one another before rapidly flying out again, an action marking off 20-second intervals. The red-tipped cannons provide eye-catching visual animation, and perhaps just as importantly, fend off enemy attacks against the core of the craft just underneath: the regulator, which has deliberately been placed in full view for all to admire.

27

STARFLEET  IN DETAILS

STARFLEET black badger

AN OUT-OF-THIS-WORLD DISPLAY

FORM FOLLOWS FUNCTION

The details of the polished movement can be fully appreciated by the naked eye, thanks in large part to Starfleet Machine's unobtrusive concentric C-shaped external structure, to which the mainplate is attached. The outermost C-shape has triangular notches next to, and in between, the three vertical arcs. These graceful supports are a stunning design feature, but also have a very practical application: to enable Starfleet Machine to be placed upside down for time-setting and rewinding. A special double-ended key fits into a cleverly designed tube in the back of the movement: one end of the key enters far enough to wind the movement; the other end penetrates the tube more deeply and allows time-setting.

STARFLEET MACHINE BLACK BADGER

James Thompson added his exclusive lume under the external ring running around the Starfleet Machine movement, to the inside of the spaceship's landing legs, and the indication domes and hands. The Black Badger touch ensures that Starfleet Machine looks just as good by night as it does by day. While most watch enthusiasts are likely to be familiar with lume in the form of

Super-LumiNova-enhanced hands and markers, that substance is quite different to the luminous material exclusive to Black Badger. While Super-LumiNova is a liquid that is applied to surfaces and dries, Black Badger's lume comes in solid blocks that are milled by hand or machine into the desired shape. Not only is Black Badger's lume extremely efficient at storing and releasing light, being solid means that there is usually more of it, so that it shines brighter for longer.

LUME

The solid Black Badger luminescent material is on the underside of the inner ring surrounding the whole structure, on the inside of the three legs supporting Starfleet Machine, on the hour and minute hands and its dome as well as on the power reserve indicators.



REFERENCES

50.6801/400

Palladium-plated with Phantom Blue lume

50.6801/401

Palladium-plated with Radar Green lume

50.6801/402

Palladium-plated with Purple Reign lume

LIMITED EDITION
OF 3X 18 PIECES IN STAINLESS STEEL,
WITH LUME IN RADAR GREEN, PHANTOM
BLUE, OR PURPLE REIGN



REFERENCES

76.6005/104

Nickel

76.6005/201

Black

76.6005/401

Blue



L'ÉPÉE 1839



M B & F

GRANT

TRANSFORMER TIME

MB&F and L'Épée 1839 present Grant, a triple-tracked, Mad-Max-cross-Transformer robot clock on a mission. In today's fast-paced, always-on, 24/7 world, we are under constant bombardment from time: seconds race by; there is never enough; everyone wants more; and it keeps getting faster and faster. The nearest hour was once precise enough; now the world's most accurate clocks are better than a second over the entire age of the universe! No wonder you are stressed, but relax, help is at hand. No wonder you are stressed, but relax, help is at hand. Grant is here. Grendizer meets Mad Max meets Transformer. d. Grant is here. Grendizer meets Mad Max meets Transformer.

Grant is a robot with a time display on his shield and a mission to slow things down when time runs too fast. There are no incessantly flashing digital numerals on Grant's shield, no constantly spinning second hand. Grant transforms frantic chaos into relaxing hours and minutes, and that's all the time you really need.

While Grant's time moves relatively slowly, he can travel quickly over rough terrain (or the messiest desk) on his three operational rubber tracks. Grant can also transform into one of three different modes: lying horizontally over his chassis for a low profile; crouching at 45 degrees; and sitting up 90 degrees. Grant's time shield can always be set to a comfortable and optimal viewing angle. Whatever the angle, Grant's highly polished clockwork is on full display, and you can follow every click and turn of the gears. The mainspring barrel click near his 'belly button' is particularly mesmerizing in operation. The isochronal oscillations of the regulator keeping time in Grant's glass-domed 'brain' are

evidence of the clockwork's high precision. Watching Grant "thinking" in real time is a stress-relieving activity in itself: Grant transforms time so that you can relax and enjoy it.

Grant's 8-day, in-line manufacture movement features the same superlative fine finishing as found on the finest wristwatches: Geneva waves, anglage, polishing, sandblasting, plus circular and vertical satin finishing.

While he doesn't look for fights, Grant believes offense is a great form of defense and packs appropriate weaponry. His left arm holds a "you-really-don't-want-to-mess-with-me" spinning disk, while his right arm clasps a removable grenade launcher. Grant even has a surprise up his sleeve: his grenade launcher is removable and doubles as the winding and time-setting key for his 8-day clockwork, so he isn't likely to run out of either firepower or time.

GRANT IS AVAILABLE IN THREE LIMITED EDITIONS OF 50 PIECES EACH IN NICKEL, BLACK, AND BLUE.



GRANT



IN DETAILS

GRANT'S TIMEKEEPING

L'Épée 1839 developed Grant to MB&F's design using its 8-day, in-line manufacture movement as a structural base. Grant doesn't just look like a complicated piece of high-precision micro-engineering, he is an incredibly solid piece of complex high-precision micro-engineering with an impressive 268 components going into the construction of his body and clockwork. That's more pieces than in many complicated wristwatches.

Under the transparent mineral glass dome on Grant's "head", the clock movement's regulator – consisting of the balance and escapement – features an Incabloc shock protection system to minimise the risk of damage when the clock is moved or transported. Shock protection is standard in wristwatch movements; however, it is unusual in clocks, which are generally stationary. But then Grant is no stationary clock; he is a robot on a mission to transform time.

Grant's 8-day movement features a mix of Geneva waves, anglage, polishing, sandblasting, circular and vertical satin finishing.

WHAT'S IN A NAME? THE GRANT TANK, AKA MEDIUM TANK, M3

Medium Tank, M3, was a medium-sized American tank in use during World War II.

In Britain, the tank came in two variations with differing turret configurations and crew sizes and each model was naturally given its own name. The Brits nicknamed the American-turreted tank «Lee», after Confederate general Robert E. Lee; the British-turreted tank was called «Grant», after Union general Ulysses S. Grant.

The M3 tank had significant firepower (like MB&F's + L'Épée 1839's Grant) and was well armoured (unlike Grant). The M3's drawbacks included a high silhouette and poor off-road performance, both issues rectified in the Grant: low profile (when laying flat) and excellent high-speed off-road performance (thanks to the threetracks).

GRANT'S TRANSFORMER POWERS

Grant transforms into three positions, each with a practical purpose.

POSITION I:

Grant's torso folds flat in his lap with his shield/time display lying horizontal across his back. This flat position enables the time to be easily read if Grant is significantly lower than the viewers' eyes and, in this relatively stable position, the winding key will wind the 8-day mainspring.

POSITION II:

Grant's torso locks securely into place at 45 degrees, from which he transforms into a more recognisably robotic shape. In this angled position, if resting on a desk or table, the time display is easily seen whether the viewer is sitting or standing.

POSITION III:

Grant's torso sits up straight at 90 degrees to his chassis, with his shield now lying vertically along his back. In this position, Grant looks most like the Mad Max warrior he sometimes longs to be (that's AI for you) and the key will now set the time.

HOWEVER (AND PLEASE KEEP THIS TO YOURSELF), THE REAL REASON GRANT TRANSFORMS INTO THREE DIFFERENT MODES IS THAT IT GIVES US THREE DIFFERENT WAYS TO PLAY!

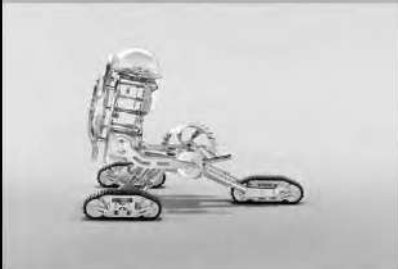

TECHNICAL SPECIFICATIONS

LIMITED EDITION
50 pieces each in Nickel, Black, and Blue
FUNCTIONS
Hours and minutes Transformer body with three operational tracks and three positions of clock/body
POWER RESERVE
8 days
MATERIALS
Stainless steel, nickel-plated brass, palladium-plated brass. Mineral glass.
ENGINE
L'Épée in-house designed and manufactured Caliber Jewels: 11
FINISHING
Geneva waves, anglage, polishing, sandblasting, circular and vertical graining, satin finishing.
WINDING & TIME SETTING
Key on right hand doubles as weapon and pulls out to reveal a key that both sets the time and winds the movement
DIMENSIONS AND WEIGHT
Truck: 115mm tall x 212mm wide x 231mm long Robot: 166mm tall x 212mm wide x 238mm deep Weight: 2.34 kg



DUET

MUSIC TO THE RHYTHM OF TIME



It was in 2012 that the opening notes of this melody began to resonate in the minds of Mr. Nicolas and Mr. Kupper, CEOs of L'Épée 1839 and Reuge respectively. They were in a Doha hotel lounge at the time, for the Doha Jewelry Show, and had started a discussion about the highly coveted "Swiss Made" label.

The idea was raised, and some initial thoughts sketched out. Two of the Swiss Jura's most typical and traditional areas of expertise—Reuge musical boxes and L'Épée table clocks—had just joined forces.

Reuge, based in Sainte Croix, celebrated its 150th anniversary in 2015. The company enjoys an excellent reputation throughout the world and is the only manufacturer of Swiss Made luxury mechanical musical boxes in existence today. L'Épée 1839 has a long tradition of horological innovation behind it and has always relished a challenge. Creating a clock that could play a tune instead of chiming the hours conventionally was a project that immediately motivated its teams. The brand has moved with the times for over 180 years and still sets the standard for animated objets d'art, not to mention the conception, design and manufacture of top-end Swiss Made table clocks. The ultimate challenge was to couple the striking mechanism complication

with the musical box. This was achieved to perfection with the addition of two options: the possibility of suspending the striking mechanism overnight and activating the melodies on demand. Then it was time to find a name for the musical clock. A few key words on a blank page jumped out: the world of music, composition, partnership, 1+1=1.

Thus the term "duet" naturally presented itself as a beautiful illustration of what Reuge and L'Épée 1839 had aimed to create with this expression of transparency and nobility embodied in a work of art. The Duet pays tribute to the shared past of the two manufactures. It is also a perfect symbol of the future of the two brands which have both, in their individual and surprising ways, made a name for themselves in the design and creation of models that deviate significantly from pure tradition. A new chapter in the stories of Reuge and L'Épée has begun...

TECHNICAL SPECIFICATIONS

CLOCK MOVEMENT

Cal. 2012 - 40 days - 5 barrels in serie - 41 Jewels

MUSIC BOX MOVEMENT

Reuge.12.72.
40 days if music played 12 times a day
Silent or continuous functions

MATERIALS

Palladium plated brass and stainless steel
Mineral Glass for housing

FINISHINGS

Include polishing, sand-blasting,
circular and vertical satin finishings

DIMENSIONS

265 x 370 x 105mm

WINDING

Manual with a single key

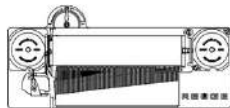

DUET CLASSIC

REFERENCE 50.6556/101

1. Canon - J. Pachelbel
2. The Four Seasons (Spring) - A. Vivaldi
3. The Magic Flute - W. A. Mozart
4. Polonaise Op.40 "Military" - F. Chopin
5. La Traviata - G. Verdi
6. The Blue Danube - J. Strauss
7. Hungarian Dance No. 5 - J. Brahms
8. Solveig's Song (Peer Gynt - Suite 2) - E. Grieg
9. Waltz of the Flowers - P.I. Tchaikovsky
10. Suite Burlesque, Dolente - G. Tailleferre
11. Waltz No.1 (Jazz-Suite 2 - D. Shostakovich
12. Edelweiss - R. Rodgers



REFERENCE 50.6556/201

1. What a Wonderful World - L. Armstrong
2. Summertime - G. Gershwin
3. Georgia On My Mind - R. Charles
4. Ain't No Sunshine - Bill Withers
5. Killing Me Softly With his Song - Roberta Flack
6. No Woman No Cry - Bob Marley
7. Here Comes The Sun - Nina Simone
8. I Feel Good - James Brown
9. Bridge Over Troubled Water - Aretha Franklin
10. Superstition - Stevie Wonder
11. Your Song - Billy Paul
12. Let The Music Play - Barry White

Link to listen to an extract :
https://soundcloud.com/lepée_musique

REFERENCES

50.6556/101

Palladium-plated brass and stainless steel - Classic melodies

50.6556/201

Palladium-plated brass and stainless steel - Soul melodies

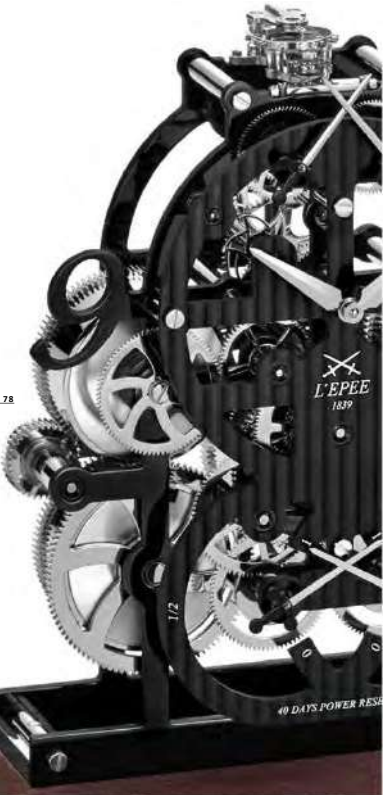

TECHNICAL SPECIFICATIONS

MOVEMENT

Cal. 2010 - 40 Days- 5 Barrels in serie

JEWELS

46

FINISHINGS

Includes Côtes de Genève, polishing, sand-blasting, circular and vertical satinfinishing, with either palladium or gold coating

DIMENSIONS

177x 207 x 100mm

MATERIALS

50.6595/001 :
Gold-plated brass movement, black main plates
50.6595/201 :
Palladium-plated brass movement, black main plates
Natural wood base and Mineral glass

WINDING

Manual-winding: Design key to set time and wind the Barrels



BLACK PEARL duel collection

THIS RESOLUTELY CONTEMPORARY COLLECTION BRINGS TOGETHER TRADITION AND FINE WATCHMAKING WITH AN ARRAY OF VISUAL EFFECTS



The plates of Le Duel Blackpearl are manufactured in brass with an allblack finish giving it great depth. Its darkness allows enhanced light effects.

The selection of materials is very important, both for their physical properties and long-term durability, as well as their graphic appearance and esthetics. Thus the Le Duel movement is primarily made of palladium-plated brass, machined exclusively at the Delémont factory in the Swiss Jura.

Machining the plates is an essential stage because it gives the movement its depth. One of them has a Côtes de Genève decoration, while the others present a polished finish with sandblasted edges. These plates are beautifully hollowed out to reveal the delicate movement, providing observers with a profound insight into the mechanics

of time. Le Duel clocks also offer the light effects that are so characteristic of L'Épée 1839 creations. Various finishes are used here to enhance the timepieces. Anglage, mirror polishing, satin finishing, circular brushing, sandblasting and polishing are all techniques perfectly mastered by the brand's craftsmen.

REFERENCES

50.6595/001

Gold plated Wheels and Black main plates

50.6595/201

Palladium plated wheels and black main plates



LA TOUR

MODERN VARIATIONS ON TRANSPARENCY



Well-versed in horological complications and specialized in high-end clocks, L'Épée 1839 proposes a varied collection of modern table clocks called "La Tour". Their sophisticated design, eight-day skeleton movement, and play on transparency and light unite around one key theme: simplicity.

DESIGN:

La Tour is inspired by the architectural currents of the early 1920s, with their minimalist approach. The collection's design is based on ideas from the Bauhaus, an artistic movement built around the creative principle that "function dictates form". As such, a succession of geartrains dictates the various curves of the plates to form a single, uncluttered whole: the skeleton movement. Having recently adopted the famous expression "Less is More".

WATCHMAKING MECHANICS:

The Swiss Made Caliber 1853 movement was created entirely by L'Épée. The La Tour collection features two plates with various finishes depending on the model selected, a complete geartrain outlining the movement, an Incabloc escapement, and a presentation structure consisting of a base and glass dome.

TECHNICAL SPECIFICATIONS

MOVEMENT

Cal. 1853 - 8 days - 18 Jewels
In house Swiss Made

MATERIALS

Brass with various finishings depending on reference

FINISHINGS

Include polishing, sand-blasting, circular and vertical satin finishings black, gold or palladium coating

DIMENSIONS

150 x 100mm

HOUSING

Brass with gold, palladium or glossy black lacquer
Mineral glass

WINDING

Unique key sets time and winds movement



REFERENCES

76.6587/001

Gold Coated movement and housing

76.6587/121

Palladium Coated movement and housing

76.6587/201

Gold coated wheels with Blackgold coated
Mainplates with gold coated housing

76.6587/211

Palladium coated wheels with Blackgold
coated Mainplates with palladium coated housing



ANGLAISE  IN DETAILS



TECHNICAL SPECIFICATIONS

FUNCTIONS		FINISHINGS
50.6731/001: Timepiece	64.6741/011: Strike, Repeat on demand, Alarm	Goldplated movement and housing with polished and satined finishings. White dial with traditional black hands
61.6741/011: Strike, Repeat, Alarm	63.6741/011: Strike, Day, Date, Moonphase	
JEWELS	DIMENSIONS	
11	Ref. 50.6731/001: 80 x 11 x 65 mm Other reference of Anglaise: 107 x 158 x 90 mm	
MATERIALS	WINDING	
Brass Gold Plated	Manual with double ended key	
MOVEMENT	POWER RESERVE	
In house: traditionnal L'Épée's carriage clock movement	8 days	



ANGLAISE
squelette

TRAVEL CLOCK



HOUR MINUTE	ALARM
STRIKE	DAY
REPEAT ON DEMAND	DATE
	MOONPHASE

L'Épée 1839 has developed a very amazing carriage clock with a surprising design approach.

From the tradition, L'Épée keeps the movement and excellence, but tempers with a modern bold goldplated skeletonized dial and main plates.

The perfectly manufactured movement can be admired through the 4 sides of this Anglaise Squelette clock.

64.6742/021

8-days swiss made - Gold plated brass movement and housing
12jewels-Manual winding

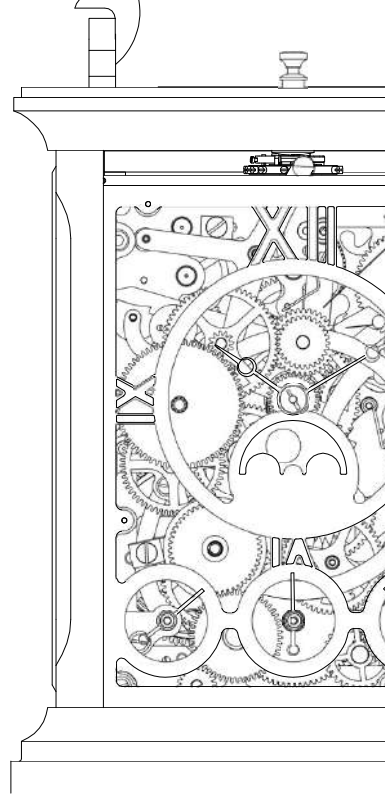



CORNICHE

CHOOSING AN ALARM CLOCK
WITH CENTURIE SOP HISTORY

The name "Corniche" comes from the elaborate moulding, or corniche, round top. The first authentic carriage clock was made in Paris at the start of the 19th Century under the auspices of the great Abraham-Louis Breguet (1747-1823).

TECHNICAL SPECIFICATIONS

MOVEMENT	FUNCTIONS
Cal. 1754A - 8 days	Hours, Minutes and Alarm
FINISHINGS	DIMENSIONS
Includes polishing, sand-blasting, circular satin finishing - Gold-plated movement and housing	82 x 112x 68mm
MATERIALS	WINDING
Brass	Manual with double ended key



CARRIAGE L'EPÉE 1839



REFERENCES

51.6021/001

Alarm



OVALE

A SIMPLE AND SOPHISTICATED HOUSING
FOR THIS TIMELESS CLOCK



REFERENCES

50.6121/001

Timepiece

61.6141/011

Strike

63.6141/011

Strike, Repeat on demand, Alarm

64.6141/011

Strike, Repeat, Alarm, Day, Date, Moonphase

CARRIAGE L'EPÉE 1839

TECHNICAL SPECIFICATIONS

FUNCTIONS
50.6121/001: Timepiece 61.6141/011: Strike 63.6141/011: Strike, Repeat, Alarm 64.6141/011: Strike, Repeat on demand, Alarm, Day, Date, Moonphase
POWER RESERVE
8 days
JEWELS
11
MATERIALS
Gold-plated brass
FINISHINGS
Goldplated movement and housing with polished and satined finishings. White dial with traditional black hands
DIMENSIONS
Ref. 50.6121/001 128 x 86 x 100 mm Other references of Ovale 154 x 128 x 106mm
WINDING
Manual with double ended key



TECHNICAL SPECIFICATIONS

LIMITED EDITION

88

JEWELS

11

MOVEMENT

Cal. 1881 T
8-day power reserve

FUNCTIONS

Hours and Minutes, Strike, Repeat on demand,
Alarm, Day, Date, Moonphase and Tourbillon

FINISHINGS

Includes polishing, sand-blasting,
circular and vertical finishings

DIMENSIONS

128 x 145 x 108 mm

MATERIALS

Brass



OVALE

tourbillon

7 COMPLICATIONS IN A TRAVEL CLOCK FOR THE MOST
DELIGHTFUL MOMENT OF THE HOUSE LIFE...

L'Épée has decided to return to one of the firm's key areas of expertise that has made the company famous over the years by designing and developing one of the complications most sought-after by connoisseurs: a "Carrousel" type tourbillon.

7 COMPLICATIONS

STRIKE / REPEAT ON DEMAND / ALARM
DAY / DATE / MOONPHASE AND TOURBILLON



REFERENCES

64.6142/001





Gold-plated movement and housing,
with a traditional white dial

c o n t a c t



L'ÉPÉE 1839
RUE SAINT MAURICE 1
2800 DELÉMONT
SWITZERLAND
TÉL: (+41) 032 421 9400

JOIN US ON :

 facebook.com/lepée1839
 fr.pinterest.com/lepée1839
 twitter.com/L_Epee_1839
 instagram.com/lepée_1839

Graphic design | **black sensitive**
studio@blackensitive.fr
www.blackensitive.fr